



HEWLETT
PACKARD

LaserJet / LJ2000 Troubleshooting Guide

Classic Printers



LaserJet I / ID (2686A/2686D)

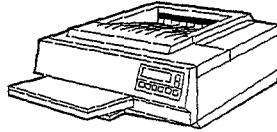

LaserJet II (33440)

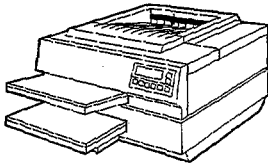

LaserJet IID (33447)

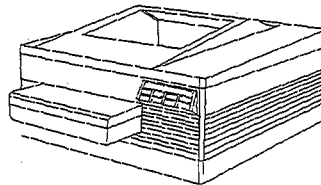

LaserJet III (33449)

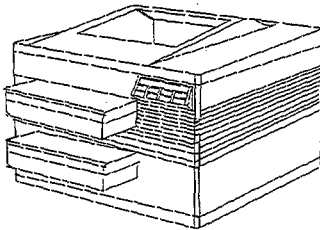

LaserJet IID (33459)

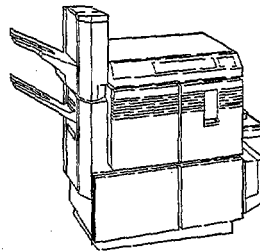

LaserJet 2000 (2684)

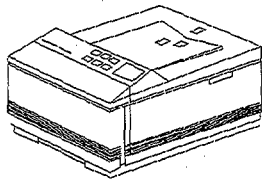

LaserJet IIP/IIP (33471/33481)

Volume 1
April 1995
Revision 13

LaserJet / LJ2000 Troubleshooting Guide



Notice

This document supercedes all previous revisions of the LaserJet/ JumboJet Troubleshooting Guide.

The information contained in this document is subject to change without any notice.

No part of this document may be photocopied, reproduced, or translated without the prior written consent of Hewlett-Packard Company.

Editor:

Bob Edwards, UK Response Centre

April 1995

Revision: 13

The Classic LaserJet Troubleshooting Manual

Contents Page - Section 1

| Page No | Contents |
|---------|---|
| 1-2 | Introduction <i>Other useful books, videos, etc</i> |
| 1-3 | LaserJet Product History <i>Cannon Engine cross-reference matrix</i> |
| 1-4 | PCL levels |
| 1-5 | Paper Related Problems / Paper Troubleshooting |
| 1-7 | Paper "Pounds (lbs) to Grams equivalence table |
| 1-8 | Paper Skew & Registration Specifications. |
| 1-9 | Toner Cartridge Troubleshooting process. |
| 1-10 | Toner Cartridge Product number & Weight <i>Toner Cartridge life</i> <i>Toner Cartridge Life expectancy in pages</i> <i>Toner Cartridge shelf life</i> <i>Toner Cartridge lot code or date code decoding</i> |
| 1-11 | Engine test with Formatter PCA de-installed <i>Half Self-test power down procedure</i> |
| 1-12 | I/O Cable Information <i>Serial Cables connected to PCs or 3000/9000 hosts</i> <i>HP 9000 RJ45 Mux cables configuration.</i> |
| 1-13 | Configuring HP LaserJets on HP3000 |
| 1-14 | HP 3000 Term-Type information |
| 1-15 | Data Transfer Rates (Serial & Parallel) |
| 1-16 | Novell Networks - 23 I/O Not Ready Troubleshooting <i>XIO JetDirect "Status Page"</i> |
| 1-18 | JetTest - The CE LaserJet Confidence Test Tool |

The Classic LaserJet Troubleshooting Manual
Contents Page - Section 2

| Page No | Description |
|----------------|--------------------------------------|
| 2-2 | Booklet Organisation & Service Notes |
| 2-3 | Faults with Error Numbers |
| 2-7 | Miscellaneous Problems |
| 2-11 | Print Quality Problems |
| 2-15 | Paper Path Problems 2686A & 2686D |
| 2-18 | <i>Paper Path Problems 2686D</i> |
| 2-20 | <i>Manual Feed Problems</i> |

The Classic LaserJet Troubleshooting Manual
Contents - Section 3

| Page No | Description |
|---------|--|
| 3-3 | Booklet Organisation: <i>Service Notes;</i> |
| 3-4 | <i>SX Engine Refurbishment Kits;</i> |
| 3-5 | <i>Service Test Tool;</i> |
| 3-6 | <i>Power Supply / Error 12 Troubleshooting Flow Diagram.</i> |
| 3-7 | Faults with Error Numbers. |
| 3-13 | Miscellaneous Problems. |
| 3-18 | Print Quality Problems. |
| 3-24 | Paper Path Problems. |
| 3-28 | PostScript Problems. <i>Manual Paper Feed Problems.</i> <i>LJII/IIID Powered Envelope Feeder Problems.</i> |

The Classic LaserJet Troubleshooting Manual
Contents Page - Section 4

| Page No | Description |
|----------------|--------------------------------------|
| 4-3 | Booklet Organisation & Service Notes |
| 4-5 | Faults with Error Numbers |
| 4-7 | Miscellaneous Problems |
| 4-11 | Print Quality Problems |
| 4-17 | Paper Path Problems |
| 4-18 | Optional Paper Tray Problems |
| 4-19 | PostScript Problems |

The Classic LaserJet 2000 Troubleshooting Manual

Contents Page - Section 5

| Page No | Description |
|--|--|
| 5-2 | Booklet Organisation |
| 5-3 | Service Note List <i>List of items the CE should Always take onsite</i> <i>Manual Part Numbers</i> |
| 5-5 | 2684 - Faults with Error Numbers |
| 5-9 | 2684 - Miscellaneous Problems |
| 5-15 | 2684 - Print Quality Problems |
| 5-19 5-19 5-21 5-23 5-27 5-33 5-34 5-35 | Paper Path Problems: <i>PDX/Cassette</i> <i>FDS (Stacker) Area</i> <i>FDS (Switchback) Area</i> <i>Duplex Area (Misc Problems)</i> <i>Duplex Area (2nd Pass Paper Jams)</i> <i>Duplex Area (I/P Paper Jams)</i> <i>Print Engine Area</i> |
| 5-38 | Paper Path LED Identification |
| 5-39 | PDX/Duplex Unit Troubleshooting Hints (using LED's) |
| 5-42 | 2684 Scope Elimination |
| 5-43 | Differences between Switchbacks (Friction v Positive Drive) |
| 5-44 | Running a) Self-Test Page b) CE Mode Paper Path Test c) Factory Run-In Mode Paper Path Test |

The Classic LaserJet Printer Troubleshooting Manual

Volume 1 - March 1995

This manual is designed to help CE's and Call Qualifiers in their goal of providing data to help quickly resolve LaserJet or JumboJet problems. Most of the problems cited are faults that have actually occurred in the field and many of these may not be included in any service manual.

This book (Volume 1) includes all the classic old LaserJets and the LJ2000. These are listed below:

| | |
|-----------|----------------------|
| 2686A | <i>LaserJet I</i> |
| 2686D | <i>LaserJet ID</i> |
| 33440 | <i>LaserJet II</i> |
| 33447 | <i>LaserJet IID</i> |
| 33449 | <i>LaserJet III</i> |
| 33459A | <i>LaserJet IIID</i> |
| 33471 | <i>LaserJet IIIP</i> |
| 33481 | <i>LaserJet IIIP</i> |
| 2684A/P/D | <i>LJ2000</i> |

LaserJets manufactured and introduced after those above will appear in later volumes. Volume 2 will include LJ4, LJ4 plus, LJIIISi/LJ4Si, LJ4L, LJ4P, LJ4V, ColorLJ and the C30 printers. This should be available by May 95.

Other Useful Books/Etc to Use in Troubleshooting Process:

- * *HP LaserJet Reference Guide (Green Book).*
- * *HP LaserJet Family Quick Reference Service Guide (5961-0716; Pocket Book)*
- * *HP 2686A/2686D Combined Service Manual (02686-90920) [1]*
- * *HP 33440 & 33449 Combined Service Manual (33449-90906) [1]*
- * *HP 33447 & 33459 Combined Service Manual (33459-90906) [1]*
- * *HP 33471 & 33481 Combined Service Manual (33481-90951) [1]*
- * *HP 2684A/P/D Service Manual (02684-90903) [1]*
- * *Paper Specification Guide (5002-1801)*
- * *Paper Specification Video (PAL 5961-0712) (NTSC 5961-0711)*

[1] Note: These manuals may be out of production

Product History

| Product | Intro-Date | Code Name | Pages/Min | PCL level | Pages/Month |
|--------------------|------------|-----------|-----------|-----------|-------------|
| 2686A (LJI) | 1984 | Sprout | 8 | 3 | 10K |
| 2686A+(LJI+) | 1985 | Sprout + | 8 | 4 | 10K |
| 2686D (LJID) | 1986 | Sprout-D | 8 | 4 | 15K |
| 33440 (LJII) | 1987 | BUD | 8 | 4 | 12K |
| 2684A/P/D (LJ2000) | 1987 | JumboJet | 20 | 4 | 100K |
| 33447 (LJIID) | 1988 | BUD-D | 8 | 4 | 16K |
| 33471 (LJIIP) | 1989 | Spud | 4 | 4 | 6K |
| 33449 (LJIII) | 1990 | Galaxy | 8 | 5 | 16K |
| 33459 (LJIIID) | 1990 | Galaxy-D | 8 | 5 | 20K |
| 33481 (LJIIIP) | 1991 | Challis | 4 | 5 | 8K |
| C2007A(LJIIIP+) | 1992 | Sunbeam | 4 | 4 | 8K |

Cannon Engines

| HP LaserJet | | Cannon Engine |
|-------------|-----------|---------------|
| IIP+ | C2007A | LBP-LX |
| IIP | 33481A | LBP-LX |
| IIID | 33459A | LBP-RX |
| III | 33449A | LBP-SX |
| IIP | 33471A | LBP-LX |
| IIID | 33447A | LBP-RX |
| II | 33440A | LBP-SX |
| ID(500+) | 2686D | LBP-CX |
| I+ | 2686A+ | LBP-CX |
| I | 2686A | LBP-CX |
| 2000 | 2684A/P/D | LBP-20 |

PCL Levels

All HP LaserJets use Hewlett-Packard's Printer Command Language (PCL). This brings all these printers under a common and consistent control structure which will ensure compatibility from one printer to another.

There are 5 PCL levels that exist at the time of assembling this book. Each higher level supercedes the previous level. If for instance a LJII were sent higher level PCL commands, such as those used with a LJ4, these would be ignored by the LJII. See table below for PCL structure:

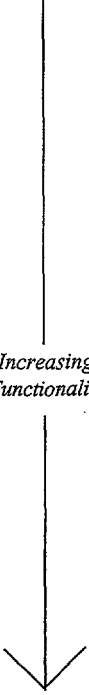
|  <p style="text-align: center;">Increasing Functionality</p> | PCL Level | Functionality | Example |
|--|-----------|---|--|
| | | 1 | Simple print & Space |
| | 2 | Plus a variety of forms, paper sizes & Margin control. | HP2932/34 dot matrix HP 256x impact printers |
| | 3 | Plus proportional spacing, bold, italics & merged text and graphics. | HP DeskJet family HP 2235A Ruggedwriter <i>LaserJet I</i> |
| | 4 | Plus additional point sizes & typefaces, downloadable soft-fonts, electronic forms & shading. | <i>HP LaserJet I+ / ID</i> <i>HP LaserJet II</i> <i>HP LaserJet 2000</i> |
| | 5 | Plus scalable typefaces, enhanced page formatting, HP-GL/2 for fast vector graphics printing. | <i>HP LaserJet III family</i> HP DeskJet 1200C |
| | 5c | Plus support for 600dpi printers, enhanced vector graphics, improved data compression. | <i>LaserJet 4 family</i> |

LaserJets & Paper Related Problems

Paper related problems are probably the most common fault that HP customer engineers have to resolve. Most customers never really consider how important paper is to ensure LaserJet printers perform well, free of paper jams and print quality problems.

This section provides guide lines for the CE to follow if paper is suspected to be to be the customers problem:

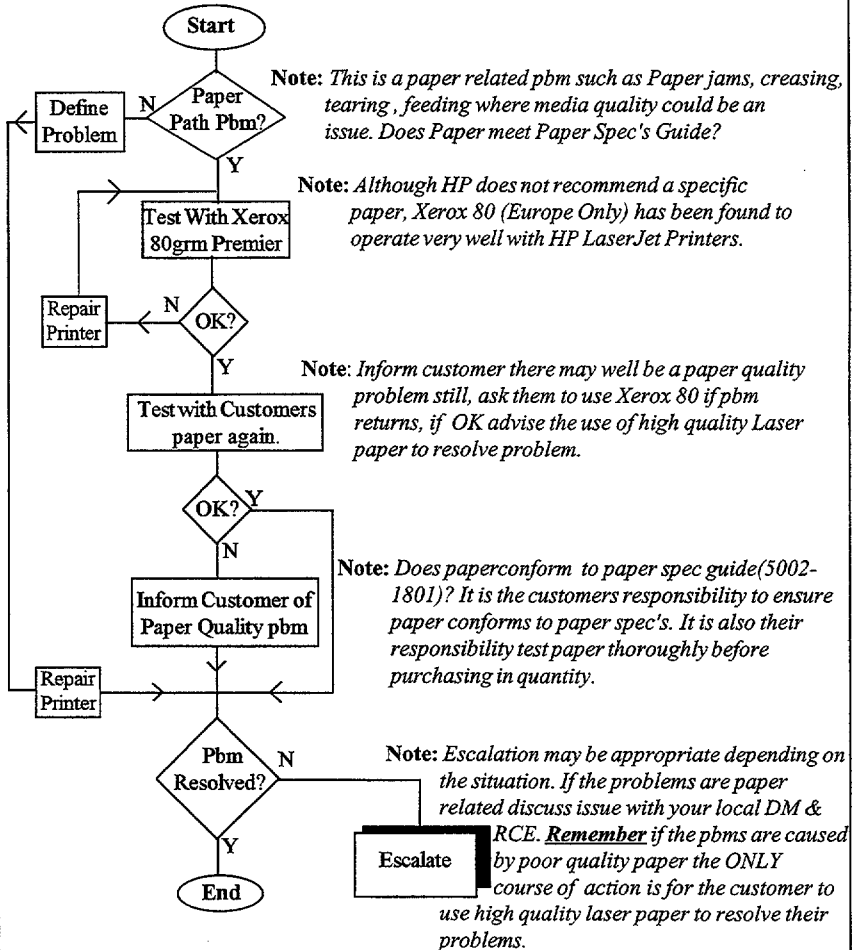

HP neither warrants or recommends the use a particular paper. Media properties are subject to change by the manufacturer & HP has no control over this. The customer assumes all responsibilities for the quality & performance of media. The customer should ensure the paper meets spec's in paper spec guide and then test in quantity to satisfy themselves the media operated well in the LJ.

CE 's Actions if Paper Problems are Suspected:

1. Ensure a High Quality Laser paper is taken on site (Xerox 80 grm Premier); do NOT leave in car overnight.
2. Take a copy of the paper spec guide (5002-1801) to give to customer. Ensure your local office has a quantity to use for this purpose. Does Paper meet Paper Spec's Guide? Does media come under the heading of "Papers likely to cause problems or papers to avoid"?
3. If paper is suspected use "Flow Diagram" to help isolate problem.
4. Keep customer involved at all times, explain how important paper is for correct operation of their printer.
5. Use HP LaserJet Reference Guide (Known as Green Book) paper section for further media information. There is a paper suppliers list in this section that customer may wish to try.
6. Show Paper Video to customer, if appropriate, this will help them better appreciate the importance of paper when used in HP LaserJet printers. (5961-0712 PAL format) or (5961-0711 NTSC format)

Factors that Contribute to Paper Path & Print Quality Problems:

- * Does the media meet the Paper Spec's outlined in Paper Spec Guide(5002-1801)?
- * Is the customers media in good condition, damaged, bent, skew, wrinkled or "Dog Eared"?
- * Are media handling practices being observed (loading paper, removing Paper Jams)?
- * Has the media customer is having problemswith ever worked?
- * Is media being conditioned before use? Media MUST stabilise in a normal office environment for a minimum of 24hr.
- * Check the following in the printer operating environment:
 - Temperature (best between 20 to 24C)
 - Humidity (Best between 45% to 55%)
 - Sunlight Exposure.
 - Cleaniness

Media Likely to give Paper Related problems:

HP cannot stop customers using any particular paper, but certain paper will give more frequent paper jam or paper path problems. Some of these are:

- * *Paper too thin or too thick (see caliper in paper spec's)*
- * *Extremely Shiny or Glossy media.*
- * *Recycled paper that has not be spec'ed for LaserJet printers.*
- * *Multi-part forms.*
- * *Media that is damaged, curled, wrinkled, ot of an irregular shape.*
- * *Papers that do not conform to A4, Letter, etc sizes and may be loose or too tight in paper trays.*
- * *Interleaving different types of media.*
- * *Paper with perforations*
- * *Some coated papers.*

- * Coloured papers
- * Papers too smooth or too rough (See Sheffield in paper spec's)
- * Papers too dry or too moist
- * Paper with embossed headers
- * Two-sided or Duplex printing on a Non-Duplex printer.
- * Paper that has been refeed into paper tray, could be from a photo-copier.
- * Preprinted Papers using low temperature inks or inks that produce hazardous emissions.
- * Labels, transparencies or envelopes that do not meet paper spec's.
- * Labels MUST cover entire backing sheet with NO gaps which expose adhesives to LJ.
- * Envelopes with open flaps with adhesive exposed.
- * Envelopes with clasps, snaps, tie strings, windows or synthetic materials
- * Envelopes with baggy construction or folds that are not sharp.

Pounds to Grams Equivalence Table

| | | |
|-------|---|-----------------------|
| 16lbs | = | 60grams/square meter |
| 20lbs | = | 75grams/square meter |
| 24lbs | = | 90grams/square meter |
| 28lbs | = | 105grams/square meter |
| 36lbs | = | 135grams/square meter |

Paper Skew & Registration Specifications

The skew and registration specifications for some of the models in the HP LaserJet Family are given below. Please note that the LJ2000 register (A4 & Letter) paper from the long edge, all other HP LaserJets are from the short edge. *These figures assume a sheet of paper with 4 right-angle corners.*

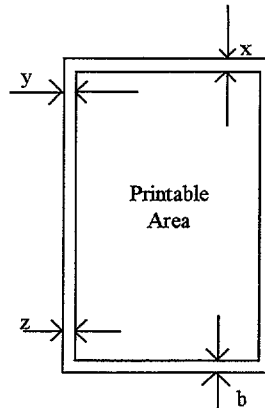

Skew (y - z)

The skew tolerance for all HP LaserJets is 1.5mm (0.06in) along the (left-hand) length, i.e. over a distance of 260mm (10.25in)

Paper Registration Specifications

Registration concerns the position of text on the paper.

| HP LaserJet | Leading Edge of paper to first horiz. dot row | Left edge of the paper to the first vertical dot row | |
|--------------|---|--|--------------------|
| | First Line/Leading Edge | A4 | Letter |
| I | 8.0mm +/- 2.0mm (x)[1] | ?? | ?? |
| II | 5.0mm +/- 2.5mm (x) | 4.0mm +/- 2mm (y) | 4.7mm +/- 2mm (y) |
| IID | 4.2mm +/- 2.5mm (x) | 4.2mm +/- 2mm (y) | 4.2mm +/- 2mm (y) |
| III | 5.0mm +/- 2.5mm (x) | 6.0mm +/- 2mm (y) | 6.4mm +/- 2mm (y) |
| IIID | 4.2mm +/- 2.5mm (x) | 6.0mm +/- 2mm (y) | 6.4mm +/- 2mm (y) |
| IIP/IIP+/IIP | 3.0mm +/- 1.0mm (x) | 5.0mm +/- 2mm (y) | 6.0mm +/- 2mm (y) |
| 2000 | 6.0mm +/- 2.5mm (x) | 4.25mm +/- 2mm (y) | 4.25mm +/- 2mm (y) |

[1] This is measured using a Self-Test page.

Note: The LaserJet IIP / IIP+ / IIP and the 2000 have a service adjustment for the top margin (leading edge of paper to first horizontal dot row.) These can only be accessed by service personnel and should only need adjustment when the DC Controller PCA is replaced.

Toner Cartridge Troubleshooting Process

When Troubleshooting problems such as Print Quality, Paper Jams or Gear Noise complaints, it is well worth considering the Toner Cartridge. In particular if non-HP Toner Cartridges are used, these are known to give a greater frequency of problems and can easily lead to customer dissatisfaction.

Please note that HP does not recommend the use of non-HP Toner Cartridges. The reasons are cited in the HP policy statement which can be found in the HP LaserJet Reference Guide (Green Book) section 5.

When Troubleshooting please use the flow diagram below to help decide if the Toner Cartridge is the cause of the problem. This can be especially useful to Call Qualifiers.

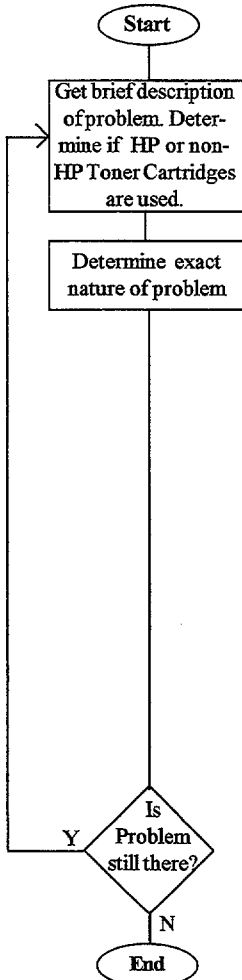

Note: In some circumstances customers may believe the toner cartridges are HP. Also in a very few cases, there are non-HP cartridge boxes designed to look like HP Toner Cartridges and deceive. *ENSURE, where possible, customer or CE use HP Toner cartridges to diagnose potential toner cartridge problems.*

Problems that Toner Cartridges can potentially cause are:

- * Paper Jams
- * Print Quality
 - Repetitive marks across page
 - Lines/Bands down page
 - Compression & Elongation of characters.
 - Faint Print
 - Ghosting images
 - Background

- * Gears Noises?
- * Error 41/51
- * Error 41.5(LJ3/4Si)
- * Toner Dumping or leaking
- * Toner runs out quickly (Toner Low)
- * Short Toner Cartridge life
- * Main Motor Errors (e.g. Error 57 LJ3/4Si)

Note: *If problem is similar to above, before embarking on replacing major LJ assemblies, try replacing the Toner Cartridge. It is quick and easy to replace.*

Note: Did you initially diagnose nature of problem incorrectly? Revisit, determine exact problem again.

Toner Cartridge Product Numbers & Weight

| HP LaserJet | Product | Cartridge | Full Weight | Empty Weight |
|-----------------------|---------|-----------|------------------------------|------------------------------|
| II / IID / III / IIID | 92295A | EP-S | 1375-1325gm 48.4 - 46.6oz | 1140-1090gm 40.1 - 38.4oz |
| IIP / IIP+ / IIIP | 92275A | EP-L | 1000-950gm 35.2 - 33.4oz | 825-775gm 29 - 27.3oz |
| I / ID | 92285A | EP-C | 1550gm 54.3oz | 1320gm 46.2oz |
| 2000 [1] [2] | 92282A | na | na | na |

Note: [1] Box contains two 0.5 Kilogram bags
 [2] This EP Drum has a P/N = R44-0230-000CN

Toner Cartridge Life

The useful expectancy of toner cartridge life depends on print density setting / Toner coverage (toner usage) and print pages (mechanical wear). Toner coverage per page is approximately 5%, for more detail please refer to the HP LaserJet Reference Guide (Green Book) section 5.

Life Expectancy for each type of Toner Cartridge is:

HP LaserJet II / IID / III / IID - 4000 pages (92295A)
 HP LaserJet IIP / IIP+ / IIIP - 3500 pages (92275A)
 HP LaserJet I / ID - 3000 pages (92285A)

Shelf Life

This is, if unopened, approximately 2.5 years of storage; the maximum shelf life of an opened cartridge is approximately 6 months. These figures are conditional on the following:

- * Store away from direct sunlight or other strong lights.
- * Store as specified on the shipping box or horizontally (flat) if out of box.
- * Store in normal office environment (i.e. a location with regulated temperature and humidity).
- * Use the cartridge before the expiry date (stamped on toner cartridge box)

The LaserJet 2000 EP Drum has a storage life of typically 2 year, provided the drum is stored at an environmental specification of 0-35 deg. C, 35-85% RH 460-760 mmHg.

Decoding Date Code or Lot Code of Toner Cartridges

Example lot code: 3D12S2

3 = year, 1993 in this case

D = month of manufacture, A=Jan, B=Feb, C=Mar, D=April, etc

12= day of month

S1 or S2 = different production lines

Engine Test with Formatter De-installed

Its not commonly known that is possible to run the "print engine test" with the Formatter PCA removed. Simply gain access to the Formatter board, disconnect it and remove. Locate the print engine test button, power on printer and press this button. *The only case where Divisions advise this will not work is the C3100A Colour printer.*

Of course there will be no display but the "Tramlines" print of the engine test should be printed. This can be useful in the following circumstances:

1. *Thin vertical black line down page, appears in same place. The Formatter PCA is known to cause this problem. Note position of line, remove Formatter, run engine test, has line disappeared?*
2. *Formatter Errors that do not allow printing to occur.*
3. *Formatter; memory SIMM's; that pull down DC power supplies. Note, DC power supplies on later printers can "crowbar" and remain down for 10 to 15 minutes.*

Location of Print Engine Test button

| | |
|------------------------|---|
| <i>LJI/ID</i> | LHS (as viewed from the front) very near rear of printer, half way up. |
| <i>LJII/ID/III/IID</i> | RHS, half way along, in lower base pan, look for plate with <i>test print</i> on it. |
| <i>LJIIP/LJIIP</i> | At rear of printer, lower rear cover door, look for access hole at top left. |
| <i>LJ2000</i> | On Operators Display Panel, simply press button. Please note there is also a "Video Test Button" on the DC Controller PCA, top LHS. |

Half Self-Test Procedure

In some cases it is very useful to look to see if the image appears on the EP Drum. To do this simply:

1. *Initiate a self-test*
2. *When the paper is approximately half past the EP Drum power the printer down.*
3. *Remove Toner Cartridge.*
4. *Is expected image self-test image on EP Drum?*

How can this help diagnose a problem. Well it splits the print quality problem in two. It tells the CE that the problem is either a Charge Corona/roller Laser problem or a Transfer Corona/roller problem. Take the example of "Blank Pages". If the "half self-test" is implemented and the image appears on the EP Drum but not the paper, this diagnoses as a transfer problem.

The "Half Self-Test" can help in the following instances:

- * *Blank pages.*
- * *Faint Print*
- * *Bands down page*
- * *Lines down page*
- * *Bands across page (Note: timing of the power down is crucial to see image on drum)*
- * *Parts of image missing.*

I/O Cable Information

PC Serial Cable Product Information

92284A Parallel 25 pin-M/ 36 pin-M 7ft (2.13m) for most IBM & Compatible PCs [1]
C2912B Parallel 25 pin-M/ 36 pin-M 9.9ft (3.0m) for most IBM & Compatible PCs [1]
24542D Parallel 25 pin-M/ 36 pin-M 6.6ft (2.0m) for most IBM & Compatible PCs [1]

17255D Serial 25 pin F/ 25 pin-M 3.9ft (1.2m) [1]
92219J Serial 9 pin F/ 25 pin-M 16.7ft (5.0m) [1]
24542G Serial 9 pin F/ 25 pin-M 9.9ft (3.0m) for most IBM & Compatible PCs [1]

92215S Serial, DIN8 6.6ft (2.0m) for Apple Mac [2]
92215N Phone NET or LocalTalk, Mac network kit [2]

Note: [1] Suitable for LJII / IID / III / IIID / IIP / IIP+ / IIP

2] Suitable for LJII / III / IIID / IIP / IIP+ / IIP

Note: Generally all cables connected to PCs, pins are crossed (i.e. pin 2 to pin 3
pin 3 to pin2)

Serial Cables connected to PCs or 3000/9000 Hosts

In general all serial cables connected to HP3000 systems have pin-to-pins connection
(i.e. pin2 to pin2 and pin3 to pin3).

ADCC 25pin/25pin: For 25pin connectors Male-to-Male cable is required to with 2, 3 &
7 wired pin-to-pin and shielded earth to pin 1(connect only one end)
Some ready-made cables are available and they are 92219G or
13242N.

ATP 3pin/25pin: Use cables 40242X or 13242X

ATP 5pin/25pin: Use cables 40242P or 13242P

9000 MUX RJ45 Cables

For connection from a Multiplexor on a 9000 host with RJ45 type connection to the serial
input of the LaserJet should be wired pin to pin as follows:

| Host | Printer | Host | Printer |
|---------------------------|---------|-------------------------|---------|
| RJ45 >>>>>>>>>>>>>>25 pin | | RJ45 >>>>>>>>>>>>>9 pin | |
| RD 1 | 2 | RD 1 | 2 |
| TD 3 | 3 | TD 3 | 3 |
| CTS 4 | | CTS 4 | |
| RTS 5 | | RTS 5 | |
| Grd 6 | 7 | Grd 6 | 5 |

Configuring HP LaserJets on HP3000

When configuring the Laserjets on the 3000 use TermType 22/PCL22 or TermType 26/PCL26. The 2686, 2684 and 33440 have Status feedback functionality and can be configured directly. The LaserJets manufactured after these products require an Optional I/O board to be installed. More detail for specific Laserjets is listed below:

LaserJet I/ ID (2686A/D)

This can be connected directly to the HP3000 as the serial I/O has status feedback. Configuration is achieved via a bank of switches which are accessed by removing the rear panel (4 screws). Switch setting are:

- 1 -OFF (Serial)
- 2 -X Baud rate selection
- 3 -X Baud rate selection
- 4 -X Baud rate selection
- 6 -ON (LJI+ only, enables ROBUSTXon)
- 8 -ON (DTR polarity set Hi)

| Baud Rate Selection | | | |
|---------------------|-----|-----|-----|
| 300 | OFF | OFF | OFF |
| 600 | OFF | OFF | ON |
| 1200 | OFF | ON | OFF |
| 2400 | OFF | ON | ON |
| 4800 | ON | OFF | OFF |
| 9600 | ON | OFF | ON |
| 19200 | ON | ON | OFF |

Note: The standard 2686A (First model produced) has only a serial I/O. The 2686A+ and the 2686D was manufactured with both Serial and Parallel I/Os.

Note: See *Cabling at the end of this 3000 configuration section.*

LaserJet II (33440)

This printer also has status feedback built into the the I/O and can be directly connected to the HP3000. This configuration settings is achieved via the operators front panel. Typical settings are:

| | |
|-------------|------------------|
| SYMBOL SET | = Roman-8 |
| I/O | = SERIAL |
| BAUDRATE | = 9600 (Default) |
| ROBUSTXon | = ON |
| DTRPOLARITY | = HI |

Note: see *Cabling at the end of this 3000 configuration section.*

LaserJet III (33449); IID (33447); IIID (33459)

These LaserJets has no status feedback, therefore cannot be connected to the HP3000, except via dummy TermType 18. To connect to the HP3000 an optional I/O board (26013A) is required to be installed in the optional I/O port at the rear of the printer. This board is no longer available, but ESI/Excellink may offer an alternative (see *HP LaserJet Reference Guide (Green book), page section 7*).

Set, via front panel, I/O to *OPTIONAL*.

LaserJet IIP (33471), IIP+(C2007), IIP(33481)

These printers do not return status and do not have an optional I/O slot. These laserJets are intended to be connected to PCs only.

LaserJet2000 (2684A/P/D)

Configuration of this printer is achieved via 2 banks of rocker switches on the Formatter board. These are accessed through a flip-down panel on the RHS of the upper section of the printer (Formatter section).

SWITCH 12 - all rockers set to OPEN

| SWITCH 14 | | | Baud Rate Selection | |
|-----------|--|--------------------------------|---------------------|-----|
| 1 | | -OPEN | | |
| 2 | | -X Baud rate selection | 600 | 001 |
| 3 | | -X Baud rate selection | 1200 | 010 |
| 4 | | -X Baud rate selection | 2400 | 011 |
| 5 | | -OPEN | 4800 | 100 |
| 6 | | -OPEN | 9600 | 101 |
| 7 | | -OPEN | 19200 | 110 |
| 8 | | -CLOSED(Select DTR polarity) | | |
| 9 | | -CLOSED(DTR handshake enabled) | | |
| 10 | | -OPEN | | |
| 11 | | -CLOSED | | |
| 12 | | -CLOSED(Xon/Xoff enabled) | | |

Note to Remember:

* *HP TermTypes for HP systems will send an ESC"E" at the beginning of a print job to reset the printer to default values.*

* *Robust Xon MUST be enabled on all HP LaserJet printers.*

* *All HP LaserJets run with 8 data bits, no parity.*

MPE Classic & XL Matrix

| Product LJ | Status Feedback | ADCC TermType | ATP 5pin TermType | ATP 5pin TermType | HP3000 system Type |
|------------------|-------------------|----------------|--------------------------|--------------------------|--|
| I/II/II | Y [1] | TTPCL22 [3] | TTPCL22 & TTPCL26 [4] | TTPCL22 & TTPCL26 [4] | MPE V/E rev V-delta 1+ MPE XL v1.2+ |
| IID/III IIID | 26013A [2] [7] | TTPCL22 [3] | TTPCL22 & TTPCL26 [4] | TTPCL22 & TTPCL26 [4] | MPE V/E rev V-delta 1+ MPE XL v1.2+ |
| 2000 | 26843A [6] [7] | TTPCL22 [3] | TTPCL22 & TTPCL26 [4] | TTPCL22 & TTPCL26 [4] | MPE V/E rev V-delta 1+ MPE XL v1.2+ |
| IIP/IIP+ IIIP | N [5] | N/A | N/A | N/A | N/A |

[1] Has status checking on-board the Formatter PCA.

[2] Plugs into rear optional I/O slot, set I/O to "OPTIONAL" on Front Panel; P/N=26013-60001

[3] TTPCL26 is not supported on ADCC; use cable 92219G or 13242N (pin to pin 2, 3 & 7, Shield pin 1 connect at one end only).

[4] TTPCL26 is preferred as status checking is done at the beginning & end of spoolfile, TTPCL22 does this at the end of every line, therefore is slower. Use cable 40242X or 13242 (3 pin), use cable 40242P or 13242P (5 pin).

[5] L/IIP/IIP+/IIIP are NOT supported on the HP3000 systems

[6] The LJ2000 serial I/O board has on-board status checking; P/N=02684-60010

[7] No longer available.

Data Transfer Rates

SERIAL Transfer Rate

Transfer rate (Kbytes/sec)

$$= \frac{\text{Baud Rate}}{8192}$$

| Baud Rate | TEXT Speed Kbytes/sec |
|-----------|--------------------------|
| 1200 | 0.15 |
| 2400 | 0.29 |
| 9600 | 1.18 |
| 19200 | 2.34 |

CENTRONICS Parallel Transfer Rate

Note: The maximum length of cable for Centronics parallel is 3 meters (10ft).

| HP LaserJet | TEXT Speed (Parallel, Kb/sec) | RASTER Speed (Parallel, Kb/sec) |
|-----------------|----------------------------------|------------------------------------|
| II | 3 | 10 |
| IID | 10 | 15 |
| IIP | 8 | 10 |
| IIP+ | 30 | 72 |
| III | 10 | 14 |
| IIID | 11 | 16 |
| IIP | 26 | 57 |
| III/IIID (16Mz) | 24 | 45 |
| AppleTalk | 20-30 | |

Novell Networks - 23 I/O Not Ready

Configuration Troubleshooting Procedure

One of the most common problems the CE will encounter when HP LaserJets are connected to Novell networks is "23 I/O NOT READY". On most occasions this problem **IS NOT A HARDWARE FAULT** and the Network Administrator should be able to correct.

Normally this is a configuration problem, that is the JetDirect card (Installed in Optional I/O slot) is not recognised by the network. Note it is the responsibility of the Network Administrator to configure JetDirect boards into network. The following steps should be adopted to check if the Novell network recognises the JetDirect card:

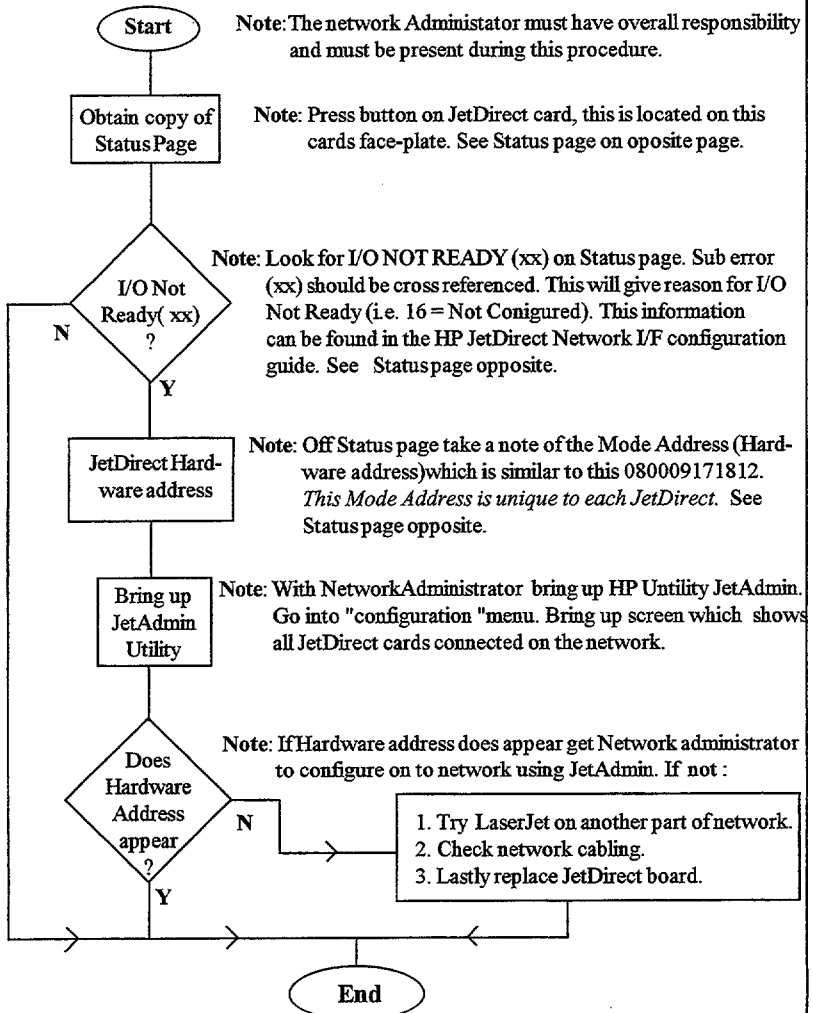

HEWLETT - PACKARD

NETWORK PRINTER INTERFACE STATUS

| | | | | | | | | | |
|---|---------------------|--|--|--|--|------------------------------------|--------------------|--------------------------------|------------------------|
| NOVELL ETHERNET/802.3 FIRMWARE REVISION: NODE ADDRESS: 080009 | 1 | NOVELL ETHERNET/802.3 REVISION FIRMWARE: U.00.04 DIRECCION NODO: 08000910280F | NOVELL ETHERNET/802.3 REVISION FIRMWARE: U.00.04 INDIRIZZO NODO: 08000910280F | NOVELL ETHERNET/802.3 FIRMWARE-REVISION: U.00.04 KNOTENADRESSE: 08000910280F | NOVELL ETHERNET/802.3 REV MICROLOGICIEL: U.00.04 ADRESSE NOEUD: 08000910280F | | | | |
| NETWORK NO.: UNKNOWN | FRAME TYPE: UNKNOWN | NUM. DE RED: DESCONOCIDO | TIPO DE TRAMA: DESCONOCIDO | NO. DI RETE: SCONOSCIUTO | PROTOCOLLO: UNKNOWN | NETZWERK-NR.: UNBEKANNT | RAHMENTYP: UNKNOWN | U ^m RESEAU: UNKNOWN | TYPE DE TRAME: UNKNOWN |
| NODE NAME: JOHN | 2 | NOMBRE DE NODO: JOHN | NOME DEL NODO: JOHN | NOME DEL NODO: JOHN | KNOTENNAME: JOHN | NOM DU NOEUD: JOHN | | | |
| NODE: QUICKSERVER | 3 | NOMBRE SERVIDOR DE FICHEROS: QUICKSERVER | SERVIDOR DE COLA: SERVER DI CODE DI STAMPA | NODO: SERVER DI CODE DI STAMPA | NODUS: MARTESCHLANGEN-SERVER | NOM DU SERVEUR FICHER: QUICKSERVER | | | |
| FILE SERVER NAME: QUICKSERVER | 4 | NOMBRE SERVIDOR DE FICHEROS: QUICKSERVER | NOME DEL FILE SERVER: QUICKSERVER | NAME DES DATEI-SERVER: QUICKSERVER | NOM DU SERVEUR FICHER: QUICKSERVER | | | | |
| I/O CARD NOT READY: LAN ERROR - EXTERNAL LI | 3 | TARJETA E/S NO PREPARADA: 03 ERROR LAN-TEST BUCLE EXTERN | SCHEDA DI I/O NON PRONTA: 03 ERRORE LAN - LOOPBACK ESTERNO | E/A-KARTE NICHT BEREIT: 03 LAN-FEHLER: ENT.SCHLEIFENTEST | CARTE E/S NON PRETE: 03 ERREUR LAN - BOUCLE EXTERNE | | | | |
| NETWORK STATISTICS: PACKETS RECEIVED: 0 BAD PACKETS RCVD: 0 FRAMING ERRORS RCVD: 0 PACKETS TRANSMITTED: 0 UNSENDABLE PACKETS: 0 XMIT COLLISIONS: 0 XMIT LATE COLLISIONS: 0 RETRANSMISSIONS: 0 | 4 | ESTADISTICAS DE RED: PAQUETES RECIBIDOS: 0 PAQUETES ERR RECIB: 0 ERRS DE TRAMA RCVD: 0 PAQUETES TRANSMIT: 0 PAQTS NO ENVIABLES: 0 COLISIONES EN XMIT: 0 COLISIONES TARD XMIT: 0 RETRANSMISIONES: 0 | STATISTICHE DI RETE: RICEV. SENZA ERR: 0 ERRORI RICEZIONE: 0 ERR. FORMATO RICEZ: 0 TRASM. SENZA ERR: 0 ERR. TRASMISSIONE: 0 COLLISIONI TRASM: 0 ULTIM COLLIS TRASM: 0 RITRASMISIONI: 0 | NETZWERK-STATISTIK: RX PAKETE: 0 RX FEHLERN. PAKETE: 0 RX RAHMENFEHLER: 0 TX PAKETE: 0 TX KEINE PAKETE: 0 TX KOLLISIONEN: 0 TX SPÄTE KOLLISION: 0 SENDEWIEDERHOLUNGEN: 0 | CONFIGURATION RESEAU: PAQUETS RECUS: 0 MAUVAIS PAQ RECUS: 0 ERR. TRAME RECUES: 0 PAQUETS TRANSMIS: 0 PAQUETS INTRANSM.: 0 COLLISIONS: 0 COLL. TARDIVES: 0 RETRANSMISSIONS: 0 | | | | |

JetTest

The LaserJet Confidence Test Tool

What is JetTest

JetTest is a confidence test tool the CE can use to quickly determine communications between the PC and the LaserJet. It also tests the functionality of the the LaserJet. This test comes on a bootable floppy disk and is very easy to use.

Why Use JetTest

- * It negates the customers application/ software as it is a bootable disk.
- * It checks communications between PC and the LaserJet or L2000. **[1]**
- * It checks the functionality of the LaserJet (i.e. Duplex, I/P source selection, etc)
- * It quickly helps CE determine if fault reported is a LaserJet problem.
- * It reduces "Over-Delivery" of HP support services.
- * It will help to reduce the NFT rate of Formatter PCA's.
- * *JetTest* will not run if disk is NOT Write Protected. (*Virus protection*)
- * Has CRC checking when disk is booting. (*Virus protection*)
- * It is very easy to use.

Note: **[1]** *It is very important to ensure a high quality I/F cable are used and they are correctly wired Use HP cable if possible.*

What are the Standard Tests

- * Ripple Test (Portrait & Landscape)
- * Graphics Test
- * Downloads a Soft-Font
- * Duplex Testing
- * I/P Bin Source Selection
- * PCL/PostScript Switching
- * PostScript Graphics test
- * Serial/Parallel protocols (*use high quality HPI/F cables if possible*)

Please note future versions of *JetTest* will contain many more tests, but the above will always be the "core standard" tests.

Which Printers can this Version of JetTest to run on?

- * LJ1 / ID (Note only ripple test has be tested)
- * LJII / IID / III / IIID
- * LJIII / IIIP
- * LJ4
- * LJIIISi / 4Si
- * LJ4L
- * LJ2000

How to RUN JetTest

1. Install the Bootable disk in A: Drive of PCA
2. Power off the PC, then on again or CTrl, Shift & DEL Keys together
3. Take approx 1 minute to BOOT-up.
4. The JETTEST screen will appear, then simply follow to menu driven screens and choose test you wish to run, number of copies, etc.

Note: The mouse will only work if the PC has serial mouse, if not use TAB and/or arrow keys.

How to Obtain a Copy of JetTest

JetTest was produced by Steve Oakes (UK Manchester) and Bob Edwards (UKRC) and has been widely distributed throughout the UK and also to many countries worldwide. If you need a copy please send a 3 1/2 inch HD floppy disk to Bob Edwards in the UK Birmingham office (ext 59369) with return address and I will be glad to send you a copy.

What of the Future of JetTest

At this time (March 95) we are in the process of updating *JetTest* to include new LaserJet products. We also intend to revamp *JetTest* to allow it to be easily updated and to include a wider choice of tests. This will probably be available by the Autumn (Fall) of this year. We will of course update the field of progress in this area.



HEWLETT
PACKARD

LaserJet / LJ2000
Troubleshooting Guide

Classic Printers

LaserJetI / LaserJetID

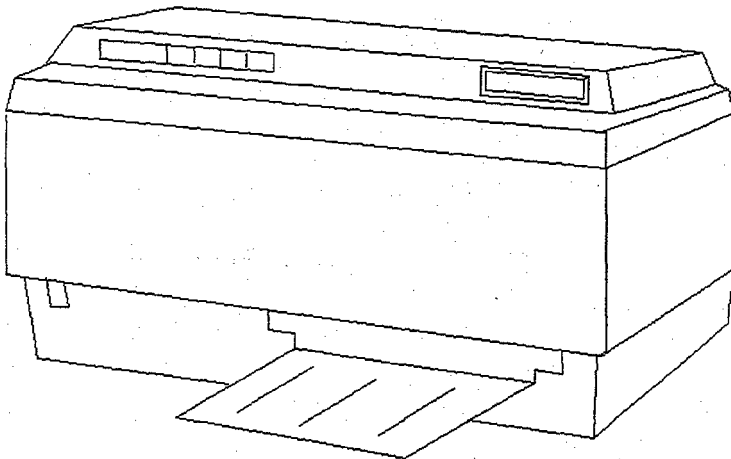

2686A / 2686D

Booklet Organisation - Please Read

This **2686A/D** section has been divided into 4 parts, which are as follows:

- 1) Faults with Error Numbers**
- 2) Miscellaneous Problems**
- 3) Print Quality Problems**
- 4) Paper Path Problems**

Service Notes up to Sept 86

| | |
|--------------|---|
| 2686A-1 | Print Skew. |
| 2686A-2 | Replacement of Lasers (DC Controller Compatibility) |
| 2686A-3 | Difficulty Clearing Error 50. |
| 2686A-4 | Service Manual changes since publication. |
| 2686A-5 | Change to Level 840606 Firmware. |
| 2686A-6 | LaserJet Plus (Options 200 & 220) |
| 2686A-7A | Vertical Smear. |
| 2686A-8 | LaserJet I/F PCA Failures. |
| 2686A-9 | Correcting Errors 20, 21, 22 & 40. |
| 2686A-10 | Correct Value for R117 on Connector J107 |
| 2686AB/AU-1 | Voltage Configuration (220/240v, 50Hz). |
| 2686AB/AU-2 | Print Skew. |
| 2686AB/AU-3 | Replacement of Lasers (DC Controller Compatibility) |
| 2686AB/AU-4 | Difficulty Clearing Error 50. |
| 2686AB/AU-5 | Service Manual changes since publication. |
| 2686AB/AU-6 | |
| 2686AB/AU-7 | LaserJet Plus (Options 200 & 220) |
| 2686AB/AU-8A | Vertical Smear. |
| 2686AB/AU-9 | LaserJet I/F PCA Failures. |
| 2686AB/AU-10 | Correcting Errors 20, 21, 22 & 40. |
| 2686AB/AU-11 | Correct Value for R117 on Connector J107. |

2686A/D - FAULTS WITH ERROR NUMBERS

Please note that all Paper Jams or Error 13 problems, refer to the Paper Path part of this section of this manual.

| | |
|--|---|
| <p>PERMANENT "02" (Long waiting)</p> | <ol style="list-style-type: none"> 1. Check Laser Power level (45mw). 2. Faulty Solid State Laser. 3. Faulty Scanner unit. 4. Check fuses on DC PS/Main Motor PCA. 5. Replace DC PS/Main Motor PCA. 6. Replace I/F PCA. |
| <p>PERMANENT "05" (Self-Test)</p> | <ol style="list-style-type: none"> 1. Faulty I/F PCA. |
| <p>ERROR 11</p> | <ol style="list-style-type: none"> 1. Caused by bad Paper cassette micro-switch (item 36, Fig-8-17). |
| <p>ERROR 11, When Manual Mode is Selected.</p> | <p>In this case the 2686A Plus was mistaken for a 2686A Std, at some time in the past the <i>I/F had replaced for a 69004 instead of a 69005</i>. At some time later the customer began to use Manual Mode and this fault appeared.</p> |
| <p>"LC 11" Lower cassette Permanently "OUT OF PAPER" (2686D)</p> | <p><i>Faulty Lower Paper Size Switch. Replace this assy.</i></p> |
| <p>PERMANENT "ERROR 12"</p> | <ol style="list-style-type: none"> 1. Faulty DC Controller. 2. When lid closes not activating switch in I/P Power Interlock assy. 3. Print engine transformer. 4. Missing DC Voltage, replace DC Power Supply/Motor Driver PCA. |
| <p>2686D ERROR 12 Intermittently (Updated) (Andy Cassels - Aberdeen)</p> | <p>The latch (FA2-5678-000CN) which holds down the upper main body on the LHS had a small crack in it. It was difficult to see the crack and printer appears to function correctly. On applying power it would intermittently give ERROR 12 or the printer would not power up at all. This was caused by the motor starting up and causing upper chassis to flex. Due to this movement (1 to 2mm), this was enough to trigger the interlock. When the interlock had operated, power is cut, motors stopped, frame returns to its correct position, then power is reapplied. This scenario can thus repeat. Replace latch FA2-5678-000CN.</p> |

2686A/D - FAULTS WITH ERROR NUMBERS (Con't)

| | |
|---|--|
| <p>2686D ERROR 12, paper not feeding correctly from both I/P trays, it "Judders", then Error 12 occurs. Also a BLANK page is emitted from the printer.</p> | <p><i>Traced to bad "Lid Switch" i.e. "DOOR OPEN". (Loss of +24v).</i></p> |
| <p>ERROR's 20, 21, 22 & 40</p> | <p>Error 20 (memory overflow) and Error 21 (print overrun) Usually caused by software due to the following: CPU/Host sent to much Data to 2686. To clear press continue.</p> <p>Error 21...The formatter cannot catch-up with print the print engine.</p> <p>Error 22 (Buffer Overflow) and Error 40 (line error)... Usually caused by system configuration problems i.e. Baud rate, parity, 7/8 bits, Xon/Xoff/DTR. Normal settings: Baud rate - 9600 Parity - None Bits - 8 bits H'shake - Xon/Xoff</p> <p><i>IN GENERAL, REPLACING I/F WILL NOT CORRECT ERROR's 20,21, 22 & 40. See Service Note 2686A-9</i></p> |
| <p>ERROR 50 Hard Fault (See note on below)</p> | <p>Normally caused by the following in order of preference:</p> <ol style="list-style-type: none"> 1. <i>The 47ohm resistor on Fuser Safety PCA blown. (obtain 1/4 watt locally) or HP P/N is FF1-3872-000CN. (See S/N 2686A-10).</i> 2. <i>Fuser Safety PCA.</i> 3. <i>AC Controller PCA.(new type has -040CN suffix).</i> 4. <i>Vibration in transporting the 2686 causes Fuser Bulb to rotate glass protrusion on fuser bulb to point towards thermistor.</i> 5. <i>Fuser Bulb, should read 9/10 ohms.(known to blow at 11 ohms).</i> 6. <i>Faulty or Dirty Thermistor.</i> 7. <i>Bad connections on the Fuser Safety or AC Controller PCA's.</i> 8. <i>Replace Triac in Power Module assy.</i> 9. <i>Faulty DC Power Supply/Main Motor PCA.</i> 10. <i>If fault persists replace Fuser Safety, AC Controller and Triac together.</i> 11. <i>Check if 2686 is configured for 240volts?</i> <p>Note: Due to error messages being retained in memory for some time after power down it can fool the Service CE into believing the assy just replaced did not resolve the problem. Either do one of two things: <i>(Continued next page)</i></p> |

2686A/D - FAULTS WITH ERROR NUMBERS (Con't)

- 1) Leave 2686 powered down for at least 10 minutes.
- 2) Alternatively, gain access to the DC Controller PCA whilst powered down and put a short across R250, near C235.

Also see Service Notes:

2686AB/AU-4 or 2686A-3 and 2686AB/AU-11 or 2686A-10

| | |
|----------------------------------|---|
| <p>INTERMITTENT ERROR 50</p> | <p>Possible causes:-</p> <ol style="list-style-type: none"> 1. <i>Noisy AC Mains Power Supply. The 2686A's are more susceptible to AC mains disturbances than perhaps other equipment. Connect AC Mains Monitor. Check quality of mains supply.</i> 2. <i>Install AC Controller who's P/N ends in -040CN suffix.</i> 3. <i>Replace Q1 Triac.</i> 4. <i>Check for AC Voltages as per below: PS/MAIN Motor PCA from Transformer. These are:- 33, 12, 21volts on J501 connector.</i> 5. <i>Check if 2686 is configured for 240v.</i> 6. <i>Noisy AC mains, install mains monitor.</i> 7. <i>See 2686A-10 Service Note.</i> 8. <i>Replace DC PS/Main Motor PCA.</i> 9. <i>Replace DC Controller PCA.</i> |
| <p>ERROR 52?</p> | <p><i>Replace I/F PCA.</i></p> |
| <p>ERROR 53?</p> | <p><i>Replace Laser unit.</i></p> |
| <p>ERROR 60 & 61.</p> | <p><i>Both these errors can be caused by faulty I/F PCA's.</i></p> |
| <p>ERRORS 63, 65 & 67</p> | <p><i>Normally caused by I/F PCA.</i></p> |
| <p>ERROR 67</p> | <p>Can be caused by <i>very cold enviroments</i> i.e temperatures in office may be falling very low over night. May give this problem only first thing in the morning, there on after will be OK all day.</p> |
| <p>ERROR 60, 65 & 67</p> | <p><i>Can be caused by attempting to put to many fonts on one page.</i></p> |
| <p>MISCELLANEOUS ERROR's 6X.</p> | <p>Especially Error's 60, 63 and 67 <i>may be caused by loose cabling.</i> If the cable are not securely fixed down the printer may exhibit these problems.</p> |

2686A/D - MISCELLANEOUS PROBLEMS

| | |
|--|---|
| ARCING? | Check all earthing associated with Transfer Corona, ensure all earth connection and all wires associated with Varistor PCA have good continuity, check 16Meg ohm(R9) by Transfer Corona is OK. |
| No FRONT PANEL DISPLAY? | <ol style="list-style-type: none"> 1. Probably the I/F power supply that lies at the bottom of the 2686A. Check the 5 volts coming from this PCA. 2. <i>Faulty I/F PCA.</i> 3. Check wires under I/F Power Supply have not been punctured, especially after reassembly. <i>If care has not been taken to route lower cables carefully, this cause unit to Smoke and damage I/F PCA.</i> |
| VERY LONG "WAITING FOR DATA" 02 on Display Front Panel. | See "PERMANENT 02" in 2686A/D "Faults with Error Numbers" at the beginning on this section of manual. |
| Will not recognise NEW CHARACTER FONTS 92286J, 92286G & 92286H. | <i>Reference Service Note 2686A-5.</i> |
| Laserjet 2686 plus outputs at 50% of expected rate with some applications when using operational fast font cartridge. | <p><i>Reference Service Note 2686A-6.</i></p> <p>Note: Throughput OK when using internal default font.</p> |
| TONER CARTRIDGE problem's | <ol style="list-style-type: none"> 1. <i>Customer not shaking cartridge.</i> 2. <i>End stops fallen out (see Video). Problem only seen in the early introduction phase of this printer.</i> 3. <i>Drum Shutter damage (L to R fade).</i> 4. <i>TONER Cartridge in red zone.</i> 5. <i>DFS Cartridge.</i> 6. <i>See "LASER PRINTER PRINT QUALITY" book. (UK Only)</i> |
| Customer changes from the 2686A to 2686D LJ. When using PREPRINTED paper that was previously used on the 2686A it was found the text had displaced by approximately 1.58mm in relationship to the preprinted lines or boxes. | <p><i>Try adjusting the physical position of the scanning unit, be aware you may increase the amount print skews on page (See S/N 2686A-1). Note there is a difference between the first printed line on 2686A when compared to a 2686D. The actual physical paper path length between the printers is slightly different, therefore a resolution may NOT be available. The customer may need to compensate by either changing the position of the preprinted images of repositioning laser printer images.</i></p> |

2686A/D - MISCELLANEOUS PROBLEMS

| | |
|---|---|
| <p>MULTIPLE I/F PCA's were being replaced ?</p> | <ol style="list-style-type: none"> 1. ENSURE the customer ALWAYS switches ON LJ last and switches OFF first. 2. If several hosts share LJ via a data switch turn off all power to LJ before switching data switch. See S/N 2686A-8 3. Has the lower section of the printer been removed from the base section recently? If so check that the two brown & blue I/F 5v supply wires have not been punctured, these lie in the base section. ENSURE all wires are returned to their correct position at reassembly. |
| <p>MULTIPLE POWER SUPPLIES REPLACED? After lower section of printer was disassembled.</p> | <p>See input above (Multiple I/F's being replaced) item number 3.</p> |
| <p>AC Controller PCA are failing?</p> | <p>Replace PTI AC Mains transformer.</p> |
| <p>Print "CRACKING" when paper is folded. White lines may be seen running through characters where page has been folded.</p> | <p>Toner comprises of pigmented plastic material and iron oxide. When subjected to high temperatures these individual plastic particles become part of a larger plastic image on the page. When the page is folded the plastic must give in some way. If the printed image is well fused into the paper , the resulting break in the plastic will NOT be very apparent. However, if the toner has NOT been able to penetrate the paper fibres, the "Crack" in the plastic image will be amplified. A white line will be seen through image.</p> <p>To Minimise:</p> <ol style="list-style-type: none"> 1. Ensure paper meets ALL Paper Specs, see guide 5002-1801. In particular pay attention to the smoothness (100-250 Sheffield) and/or "Wax Pick" (>11 Dennison) 2. A lighter Density setting will ensure less toner is used, thus minimising problem. 3. A lighter character stroke may also help |
| <p>PRINT SKEWING & Paper REGISTRATION problems.</p> | <p>Reference Service Note 2686AB/AU-2. <u>Acceptable Skew is 1.58mm over 260mm feed from Cassette tray</u></p> <ol style="list-style-type: none"> 1. Replace Registration assy, check that white nylon rollers turn freely. 2. Is media within spec's for this printer? 3. Replace Paper cassette tray. 4. Laser/scanner Unit misaligned? See Service Note 2686AB/AU -2. |

2686A/D - MISCELLANEOUS PROBLEMS (Con't)

| | |
|--|--|
| <p>TRAILING EDGES OF ENVELOPES "Wrinkled" as it passes through fuser assy.</p> | <p>Adjust spring tension on Fuser Pressure rollers, this may help. <i>Note, envelopes are problematic due to their construction. Contact RCE for further information</i></p> |
| <p>Customer printing BOTH SIDES of the Page or DUPLEX printing? This may cause paper jams, paper feeding or print quality problems.</p> | <p>This model of LaserJet is a SIMPLEX printer and is not designed for Duplex printing. Although this printer can print on both sides, <i>this practice is not supported by HP</i>. For the general HP statement on "<i>Duplex printing v Simplex</i>" please reference HP Reference Guide (Green Book) section 3.</p> |
| <p>Customer REFEEDING paper, not two sided printing?</p> | <p>As above refer to HP general statement on "<i>Duplex printing v Simplex</i>" in HP Reference Guide (Green Book) section 3.</p> |
| <p>PAPER JAMS/MISFEEDS/SKEWING caused by customers practice of INTERLEAVING different types of paper in paper trays?</p> | <p><i>Interleaving, where a variety of paper is placed in the paper tray, is not recommended by HP</i>. This practice is likely to lead to Paper jams & Misfeeds. For the general HP statement on "<i>Interleaving Paper</i>" please reference HP Reference Guide (Green Book) section 3.</p> |

2686A/D - PRINT QUALITY PROBLEMS

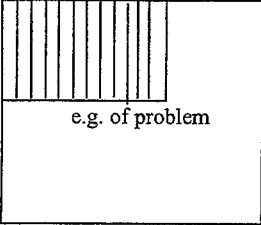
| | |
|---|---|
| <p>MARKS ON PAPER AT REGULAR INTERVALS</p> | <p>If marks repeat at regular intervals, measure distance between marks to determine where the problem lies:- <i>Marks 7.375" apart - Drum Related.</i> <i>8.0" apart - Drum gear Related</i> <i>2.5" apart - Fuser Roller Related</i></p> |
| <p>Prints in only a small portion of the page with "Print Test" and only a small portion of "Self Test". See below:</p>  <p style="text-align: center;">e.g. of problem</p> | <p><i>Paper tray size microswitch problem.</i> Check operation of these switches, alternatively paper size switch cables may be defective. There are 3 microswitches to the left of the paper tray, which sense type of paper tray (A4, 11x 8.5, etc) installed.</p> |
| <p>ELONGATION OF PRINT in the direction of paper movement.</p> | <ol style="list-style-type: none"> 1. <i>Replace DC PS/Main Motor PCA.</i> 2. <i>Check drive mechanism, gear train & motor</i> 3. <i>Replace main motor</i> 4. <i>Is the use of Non-HP Toner Cart's causing this pbm?</i> |
| <p>BACKGROUND</p> | <ol style="list-style-type: none"> 1. <i>Adjust Print Density dial.</i> 2. <i>Ground Spring in centre of drum drive gear, is it damaged or missing?</i> 3. <i>Check Laser Power adjustment</i> 4. <i>Replace HVPS.</i> 5. <i>Replace DC Controller PCA.</i> 6. <i>Replace DC Power Supply /Main Motor Dvr PCA.</i> |
| <p>VERTICAL SMEAR problem. Thin grey band in approx middle of paper . Band in the direction of paper movement. This band is Approx 6 to 12mm wide. This problem is also known as "VERTICAL FOGGED STRIPES".</p> | <p>Reference Service Note 2686A-7.</p> <ol style="list-style-type: none"> 1. <i>Pay special attention to the quality of media used.</i> 2. <i>Supply customer with 2686A Paper Spec's Guide.</i> 3. <i>Replace Feed Guide Assy (RG1-1039-000CN)</i> 4. <i>Dirty Primary Corona.</i> 5. <i>Try replacing Toner Cartridge.</i> 6. <i>Clean interior of printer.</i> |
| <p>WAVY PRINT</p> | <ol style="list-style-type: none"> 1. <i>Replace Scanner unit</i> 2. <i>Replace DC Controller PCA.</i> |

2686A/D - PRINT QUALITY PROBLEMS (Con't)

| | |
|--|--|
| <p>MARK ON PAPER in line with SEPARATION BELT.</p> | <ol style="list-style-type: none"> 1. Separation belt installed upside down. 2. Dirty Separation Belt. 3. Dirty Separation Roller. 4. Replace Toner Cartridge. |
| <p>GHOST CHARACTER on the 43rd line?</p> | <p><i>Overfilling the paper tray can the pick-up rollers to drag on the paper, causing motor to slow down, causing EP Cartridge to stall slightly. Causing improper transfer of printed data from drum to paper.</i></p> |
| <p>LIGHT IMAGES?</p> | <ol style="list-style-type: none"> 1. Adjust Print Density Dial. 2. Try Laser Quality Paper. 3. Replace Transfer Corona. 4. Check Laser Power. (Laser Checker Tool) 5. Replace HVPS. 6. Replace DC Controller PCA. 7. Check Drum Sensitivity switches. |
| <p>RANDOM LIGHT PATCHES over the page or GRADIENT from left to right?</p> | <p><i>Clean centre of large brass drum drive gear. BEWARE, do not damage or lose spring in the centre of this brass gear.</i></p> |
| <p>LIGHT PRINT ON RHS side of paper in the direction of paper movement.</p> | <ol style="list-style-type: none"> 1. Due to a missing or loose earth connection on 2686A situated near the RHS hinge as viewed from the front of the printer. 2. Missing Doctor blade pin in EP Cartridge, replace EP Cartridge. Have not seen this problem for a long time. 3. Replace Varistor PCA, there may be differences of output, i.e. narrow bands of dark print at the far RHS, whereas a missing doctor blade pin will not. |
| <p>LIGHT AREA, bottom RHS and irregular.</p> | <p><i>Replace Feeder Guide Assy and possibly the Transfer Corona.</i></p> |
| <p>LIGHT PRINT in same position down page? Always in direction of paper movement. Image very light in in this area.</p> | <p><i>Clean Optics Exit mirror to Drum.</i></p> |
| <p>BLANK PAGES?</p> | <ol style="list-style-type: none"> 1. Empty toner cartridge? 2. Has seal been removed in toner cartridge? 3. Replace Transfer corona, wire broken? 4. Replace HVPS. 5. Replace DC Controller.PCA. |
| <p>BLACK PAGES?</p> | <ol style="list-style-type: none"> 1. Replace EP Toner cartridge. 2. Replace HVPS. |

2686A/D - PRINT QUALITY PROBLEMS (Con't)

| | |
|--|---|
| <p>Sharp THIN LINES Horizontal Lines across Page</p> | <ol style="list-style-type: none"> 1. <i>Replace Scanning Assy</i> 2. <i>Replace Laser Unit</i>, check laser power. 3. <i>Replace DC POver Supply/Main Motor Dvr PCA.</i> |
| <p>RANDOM GAPS between consecutive lines across page?</p> | <p><i>Faulty brass drum drive gear</i>, the centre collar was protruding which prevented the silver pin locking in the end of the EP cartridge. This resulted in the drum stopping intermittently.</p> |
| <p>THIN VERTICAL "BLACK" LINES/STRIPES down page?</p> | <ol style="list-style-type: none"> 1. <i>Is Fuser Cleaning Pad dirty? Replace if necessary..</i> 2. <i>Scoring on fuser roller? replace if necessary.</i> 3. <i>Scoring on EP Cartridge, try another cartridge.</i> |
| <p>THIN VERTICAL "WHITE" LINES/STRIPES down page?</p> | <ol style="list-style-type: none"> 1. <i>Replace Toner Cartridge.</i> 2. <i>Dirty Fuser Cleaning Pad.</i> 3. <i>Dirty Transfer Corona wire.</i> 4. <i>Check for obstacles or O/P mirror contamination in laser beam path. Laser Shutter?</i> 5. <i>Replace scanning assy.</i> |
| <p>BANDS Down page ? Fuser Rollers scored.</p> | <p>Scoring is normally <i>caused by a build up of dust, etc on the fuser separation pawls</i> (page 8-58 item 34). This problem is accentuated by the use of non-suppported media i.e paper with a high cotton content or with talc/clay content. See 2686 Paper Spec Guides. The use teflon coated damage resistant fuser rollers have been found to be more reliable. <i>Use High Quality Laser media as per paper spec's.</i></p> |
| <p>PRINT SKEWING & Paper REGISTRATION problems.</p> | <p><i>Reference Service Note 2686AB/AU-2. <u>Acceptable Skew is 1.58mm over 260mm feed from Cassette tray</u></i></p> <ol style="list-style-type: none"> 1. <i>Replace Registration assy</i>, check that white nylon rollers turn freely. 2. <i>Is media within spec's for this printer?</i> 3. <i>Replace Paper cassette tray.</i> 4. <i>Laser/scanner Unit misaligned? See Service Note 2686AB/AU -2.</i> |
| <p>STAINS on REAR of PAPER</p> | <ol style="list-style-type: none"> 1. <i>Clean interior of printer.</i> 2. <i>Dirty Fuser Cleaning Pad.</i> 3. <i>Replace Fusing assy.</i> |
| <p>EP Cartridges DEGRADING extremely quickly of found to be D.F.S on arrival.</p> | <p><i>Check the EP Cartridges are HP and are not refilled EP Cartridges.</i> BEWARE, although the cartridges may be in a HP or look alike boxes, it still could be of the refilled variety.</p> |

2686A/2686D - PAPER PATH PROBLEMS

| | |
|---|---|
| <p>ERROR 13's Paper Jams (Summary)</p> | <ol style="list-style-type: none"> 1. Using <i>UNSUPPORTED PAPER</i>, 79 grms max, use high quality laser bond paper to test. 2. Paper Jams/Smears - <i>caused by broken or missing separation belt or incorrectly installed.</i> 3. Paper Jams caused by EP Toner Cartridge shutter not opening. <i>The plastic strut in the base(RHS) base (RHS) which opens this shutter was broken.</i> 4. Paper Jam caused by <i>Paper Cassette clutch collet (item-4, Fig 8-17) loose.</i> This also applies to 2686D's. 5. Paper jams at rear access door - <i>due to a restriction in the guide from the rear access up to the registration assy.</i> Use slightly stiff card stock and push up from the rear access door area into this guide to clear obstruction. 6. Paper Jam at Registration area - <i>Registration solenoid binding or shutter not moving correctly.</i> Replaced registration assy. 7. Paper Jam at Registration Assy - <i>due to cover hinges incorrectly set causing a lack of friction between the registration rollers.</i> 8. Paper Jam at Fuser Assy - <i>caused by fuser exit sensor.</i> |
| <p>FIRST PRINTED PAGE JAM'S, but operates OK thereon afterwards until the printer has been turned off or unused for some time. (ERROR 13)</p> | <p>See page 8-49 in Service Manual, item 9 Registration Shutter assy. On this assy there is a rubber grommet which when the printer is unused for a period of time sticks. This causes the Registration assy not to operate correctly, thus Paper Jam. <i>Remove this grommet as a temporary measure, replace registration assy at a later time if not immediately available.</i></p> |
| <p>FALSE PAPER JAMS, no paper fed at all. (ERROR 13)</p> | <p>Springs on Registration Shutter assy not positioned correctly, fooling the LJ into believing paper has stuck in this assy. i.e. sensor activated at all times. <i>Reposition these springs into its correct location or replace registration assy.</i></p> |
| <p>FALSE PAPER JAMS, i.e paper feeds thru OK, but with no printing, then a false paper jam occurs. (ERROR 13)</p> | <p>Ref page 8-37 item 4/25, the allen screw may come loose or it may slip on its shaft. This results in the "D" cassette pick roller incorrectly positioned.</p> <ol style="list-style-type: none"> 1. <i>Flat edge of 'D' roller should face paper tray, or</i> 2. <i>Too much paper in paper tray may cause the same problem.</i> |
| <p><i>On power up, before power up initialisation has completed,</i> main motor energises ERROR 13 occurs.</p> | <p>Registration Sensor arm binding. A misalignment of the Registration Shutter Spring (page 8-49, item 15) <i>Realign to correct problem.</i></p> |

2686A/2686D - PAPER PATH PROBLEMS (Con't)

| | |
|--|---|
| <p>PAPER JAMMING at rear of printer, in area between rear access door and Reg Assy.</p> | <p>From rear of 2686A, pull back Lower Cassette guide (page 8-37, item 7), <i>push some fairly rigid paper up towards registration area to clear any blockage. Alternatively the guide plates in this area are too close and will have to be stripped down to correct this problem.</i></p> |
| <p>ERROR 13 - 1st page leaves 1" protruding from fuser assy.</p> | <p><i>Replace Exit fuser Sensor.</i></p> |
| <p>ERROR 13 - Occurs when leading edge of paper is about to enter separation belt roller.</p> | <p><i>Replace EP Cartridge, either shutter not opening or it is restricting paper movement.</i></p> |
| <p>ERROR 13 - Occurs after paper is picked up, all movement stops then jam message.</p> | <p><i>Replace back door springs (RSI-2011-000CN).</i></p> |
| <p>ERROR 13 when warming up. Does not get to "00 READY " condition before paper jam occurs.</p> | <ol style="list-style-type: none"> 1. <i>Registration plate bent or misaligned, also check springs on this assy.</i> 2. <i>Replace Registration assy.</i> |
| <p>PERMANENT ERROR 13 on switching-on.</p> | <p>The 24v was being pulled down by faulty AC Cont PCA. <i>Replace AC Controller PCA.</i></p> |
| <p>ERROR 13, 6mm of Paper protruding out of the Fuser Rollers.</p> | <p><i>Replace Fuser Exit Sensor.</i></p> |
| <p>2686A Paper Jams when user begins operating printer for the first time in the morning. No problems after first initial uasage.</p> | <p>Paper Feed clutch found to be heavily congeled in grease/paper dust. <i>Thoroughly cleaning clutch resolved problem.</i></p> |
| <p>LOSING TOF when using label paper from the manual feed I/P tray.</p> | <ol style="list-style-type: none"> 1. <i>Check quality of Labels.(Use Avery)</i> 2. <i>Replace Manual Feed Assy(FGI-2354-000CN).</i> 3. <i>Check alignment of manual idler roller on Reg assy in relationship to roller on the manual feed assy.</i> |
| <p>2686D - in FACE-DOWN MODE RH edge of paper BENT over.</p> | <p><i>Nylon rollers slipping on paper pick-up shaft (item 15, Fig 8-21).</i></p> |

2686A/2686D - PAPER PATH PROBLEMS (Con't)

| | |
|--|--|
| <p>PRINT SKEWING & Paper REGISTRATION problems.</p> | <p><i>Reference Service Note 2686AB/AU-2. <u>Acceptable Skew is 1.58mm over 260mm feed from Cassette tray</u></i></p> <ol style="list-style-type: none"> 1. Replace Registration assy, check that white nylon rollers turn freely. 2. Is media within spec's for this printer? 3. Replace Paper cassette tray. 4. Laser/scanner Unit misaligned? See Service Note 2686AB/AU-2. |
| <p>First page OK, second sheet, text has SHIFTED DOWN page.</p> | <p>Sticky registration shutter/solenoid. Replace Registration assy.</p> |
| <p>Faulty REGISTRATION i.e. Print shifted down page by approximately 2 inches.</p> | <p>Registration assy jammed, replace this part.</p> |
| <p>LINE SPACING between 2686 & 33440A NOT THE SAME?</p> | <p>The LJII has a different paper handling path when compared to the 2686A. HP specify that line difference can vary by +/- 2.5mm per page.</p> |
| <p>TRAILING EDGES OF ENVELOPES "Wrinkled" as it passes through fuser</p> | <p>Adjust spring tension on Fuser Pressure rollers, this may help. <i>Note, envelopes are problematic due to their construction.</i></p> |
| <p>Customer printing BOTH SIDES of the Page or DUPLEX printing? This may cause paper jams, paper feeding or print quality problems.</p> | <p>This model of LaserJet is a SIMPLEX printer and is not designed for Duplex printing. Although this printer can print on both sides, <i>this practice is not supported by HP.</i> For the general HP statement on "<i>Duplex printing v Simplex</i>" please reference HP Reference Guide (Green Book) section 3.</p> |
| <p>Customer REFEEDING paper, not two sided printing?</p> | <p>As above refer to HP general statement on "<i>Duplex printing v Simplex</i>" in HP Reference Guide (Green Book) section 3.</p> |
| <p>PAPER JAMS/MISFEEDS/SKEWING caused by customers practice of INTERLEAVING different types of paper in paper trays?</p> | <p><i>Interleaving, where a variety of paper is placed in the paper tray, is not recommended by HP.</i> This practice is likely to lead to Paper jams & Misfeeds. For the general HP statement on "<i>Interleaving Paper</i>" please reference HP Reference Guide (Green Book) section 3.</p> |

2686D - PAPER PATH PROBLEMS

| | |
|---|---|
| <p>2686D - ERROR 13, feeds OK from upper tray, jams from lower tray. ALWAYS prints 1st page, 2nd page is just leaving the fuser assy, 3rd page is half way up the rear access door, paper jam occurs</p> | <p><i>Replace registration assy and CHECK quality of the media being used.</i> If paper is NOT checked the problem will most likely recur again. NOTE: Media is known to cause this problem, use paper that meets 2686A/D Paper Spec's guide.</p> |
| <p>2686D - When paper is fed from UPPER TRAY, one sheet is fed incorrectly from the LOWER TRAY?</p> | <p><i>Sticky lower clutch, possibly caused by using incorrect lubricant.</i> Dismantle clutch, clean and use light oil to lubricate.(3-in-One) Replace clutch spring and other parts if necessary. DO NOT use grease.</p> |
| <p>2686D, When labels are fed manually, the image loses TOF and also manual I/P seems to snatch at label when feeding.</p> | <p>Ensure Idler roller on the Manual feed assy are aligned with the lower Manual feed roller. <i>Bend metalwork on idler assy (Page 8-48 P/N FGI-2354-000CN) to correct.</i></p> |
| <p>ERROR 13 - 2686D after paper exits delivery exit area in face in face up mode or in face down mode. This error occurs when paper is about to enter the holding tray area.</p> | <p><i>Delivery sensor PS6 faulty, though it seemed OK when measured with a DVM.</i></p> |
| <p>ERROR 13 - 2686D, PAPER JAMS IN HOLDING TRAY AREA. Paper entering holding Tray from fuser assy collides with paper about to exit the the holding tray.</p> | <p><i>1. Adjust pot on Paper Control PCA, this controls the speed of paper exiting the holding tray.</i> NOTE:- these pots are initially factory set</p> <p><i>2. Replace Paper Control PCA.</i></p> |
| <p>2686D ERROR 12 Intermittently</p> <p><i>(Updated)</i> <i>(Andy Cassels - Aberdeen)</i></p> | <p>The latch (FA2-5678-000CN) which holds down the upper main body on the LHS had a small crack in it. It was difficult to see the crack and printer appears to function correctly. On applying power it would intermittently give ERROR 12 or the printer would not power up at all. This was caused by the motor starting up and causing upper chassis to flex. Due to this movement (1 to 2mm), this was enough to trigger the interlock. When the interlock had operated, power is cut, motors stopped, frame returns to its correct position, then power is reapplied. This scenario can thus repeat. <i>Replace latch FA2-5678-000CN.</i></p> |

2686D - PAPER PATH PROBLEMS (Con't)

| | |
|---|--|
| <p>IN FACE-DOWN mode right hand edge of paper has bent over.</p> | <p><i>Nylon roller slipping on paper-up shaft (item 15, Fig 8-21).</i></p> |
| <p>Customer changed from 2686A the 2686D. When using paper preprinted paper on the 2686D which was used successfully on the 2686A, the text has moved by approximately 1.58mm.</p> | <p><i>Try adjusting position of scanning assy, be aware the amount of print skew on printed page may increase (see S/N 2686A-1). Note there is a difference between the 1st printed line on the 2686A, when compared to the 2686D. In this case, a problem resolution may not possible which could be offered to the customer. There are differences between the physical paper paths.</i></p> |
| <p>The printer has TWO PAGES coming out of the fuser assy. The 1st page is 25 to 50mm in front of the 2nd page.</p> | <p>The paper tray clutches are NOT stopping after one revolution. Try :</p> <ol style="list-style-type: none"> 1. Check if tension provided by the solenoid armature spring is sufficient. 2. Replace clutch spring and lubricate with light oil. (e.g. 3-in-One Oil). |
| <p>Customer printing BOTH SIDES of the Page or DUPLEX printing? This may cause paper jams, paper feeding or print quality problems.</p> | <p>This model of LaserJet is a SIMPLEX printer and is not designed for Duplex printing. Although this printer can print on both sides, <i>this practice is not supported by HP.</i> For the general HP statement on "Duplex printing v Simplex" please reference HP Reference Guide (Green Book) section 3.</p> |
| <p>Customer REFEEDING paper, not two sided printing?</p> | <p>As above refer to HP general statement on "Duplex printing v Simplex" in HP Reference Guide (Green Book) section 3.</p> |
| <p>PAPER JAMS/MISFEEDS/SKEWING caused by customers practice of INTERLEAVING different types of paper in paper trays?</p> | <p><i>Interleaving, where a variety of paper is placed in the paper tray, is not recommended by HP.</i> This practice is likely to lead to Paper jams & Misfeeds. For the general HP statement on "Interleaving Paper" please reference HP Reference Guide (Green Book) section 3.</p> |
| | |

2686A/D - MANUAL FEED PROBLEMS

| | |
|---|---|
| <p>2686D, When labels are fed manually, the image loses TOF and also manual I/P seems to snatch at label when feeding.</p> | <p>Ensure Idler roller on the Manual feed assy are aligned with the lower Manual feed roller. <i>Bend metalwork on idler assy (Page 8-48 P/N FG1-2354-000CN) to correct.</i></p> |
| <p>LOSING TOF when using label paper fed from manual feed input tray.</p> | <ol style="list-style-type: none"> <i>1. Check quality of Labels.(Use Avery)</i> <i>2. Replace Manual Feed Assy(FG1-2354-000CN).</i> <i>3. Check alignment of manual idler roller on.</i> |
| <p>NO MANUAL FEED, ERROR 11 OCCURS when MANUAL FEED is SELECTED.</p> | <p><i>Ensure correct interface pca is installed, should be 69005 not 69004.</i> 02686-69005 for 2686A+ & 2686D(serial & Parallel) 02686-69004 for Std 2686A (serial I/F only)</p> |
| <p>MANUAL FEED, Two pages of data printed on same page.</p> | <p><i>Customer not pressing FORMFEED after manually feeding paper, results in 2 pages of data on one page.</i></p> |
| <p>Feeds one sheet via manual I/P, gives permanent status ERROR 11 (paper out) cleared temporarily by powering down printer.</p> | <p><i>Replace Interface PCA!</i></p> |
| | |



Classic Printers

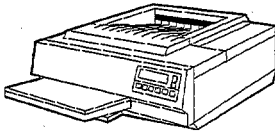

LaserJet II (33440)

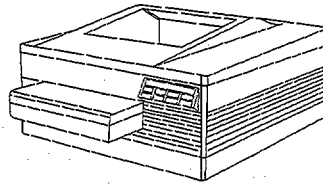

LaserJet III (33449)

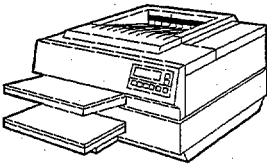

LaserJet IID (33447)

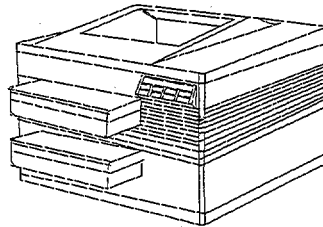

LaserJet IIID (33459)

33440A/33447A/33449A/33459A LaserJet Printers

Booklet Organisation - Please Read

This section has been divided into 4 parts, which are as follows:

- 1) **Faults with Error Numbers** [*Error 13's {Paper Jams} in Paper Path section*]
- 2) **Miscellaneous Problems**
- 3) **Print Quality Problems**
- 4) **Paper Path Problems** [*All Error 13's {Paper jams} in this section*]
- 5) **PostScript Problems**
- 6) **LJIIID / IIID Only Faults**
- 7) **Appendix**

Service Notes up to Feb 95

| | |
|---------------|--|
| 33440A-1 | Parallel I/O Incompatibility |
| 33440A-2 | Shim Under Laser / Scanner Unit |
| 33440A-3 | Rubber Foot |
| 33440A-4 | RS-422 Operation |
| 33440A-5 | Laser Power |
| 33440A-6 | White Pages |
| 33440A-7 | Replaceable Ozone Filter & Housing |
| 33440A-8 | NTF Rate of the LJ Interface PCA |
| 33440A-9 | Error 41, 50, 51 or 52 Error's and cable P/N's |
| 33440AB/AU-9 | Error 12 & 55 connected to Vectra ES, CS, ES/12 or QS using 220/240v |
| 33440A-10 | Lubrication of Fuser Assy Ground Contact. |
| 33440A-11 | Upper Cooling Fan |
| 33440A-12 | Fuser Assy - Potential Safety Concern |
| 33440A-T-1 | Internal Cable replacement |
| 33447AB/AU-1 | AC Power Module (Incorrect P/N) |
| 33447AB/AU-2 | Lubrication of Fuser Assy Ground Contact. |
| 33447AB/AU-3 | Replacement of Duplex Drive Roller Clutch |
| 33447AB/AU-4 | Packaging the LJD for Shipping |
| 33447AB/AU-5 | Printing Labels in Duplex Mode is NOT supported |
| 33447AB/AU-6 | Upper Cooling Fan |
| 33447AB/AU-7 | Duplex Paper Jams |
| 33447AB/AU-8 | HP26013A Status readback I/O |
| 33447AB/AU-9 | Fuser Assy - Potential Safety Concern |
| 33447AB/AU-10 | Light Brown "Oil-Like" Stain on the Front Side of a Duplexed Page. |
| 33449A-01A | LaserJet III Update for HP 33440 Personnel. |
| 33449A-02 | HP26013A Status Readback I/O (Optional I/O PCA) |
| 33449A-03 | Opening the Top cover when the Release Button is Inoperative. |
| 33449A-04 | DC Controller PCA, Interchangeability Notice. |

33449A-05 Fuser Assy - Potential Safety Concern

33459A-01A LaserJet IIID Update for the HP33447A Service Personnel.
 33459A-02 DC Controller PCA, Interchangeability Notice.
 33459A-03 Fuser Assy - Potential Safety Concern
 33459A-04 Light Brown "Oil-Like" Stain on the Front Side of a Duplexed Page.

33443A-1 1 Mb Memory Card Accessory
 33444A-1 2 Mb Memory Card Accessory
 33445A-1 3 Mb Memory Card Accessory

26013A-1 HP26013A Status readback I/O

88141A-1 JetScript, Warranty Processing & Quality Tracking

33439P-01 HP 33439P/Q PostScript Cartridges
 33439Q-01 HP 33439P/Q PostScript Cartridges

LJ2/2D/3/3D SX Engine Refurbishment Kit

Both the 240v & the 115v SX engines now have a Service Maintenance Kit available. This kit is made available for long term wear and the printer still has NO PM schedule provision. The P/N for these kits are:

- * 33449-69008 240v kit
- * 33449-69007 115v kit

This kit includes the following parts for the LJII and LJIII:

- 240v or 115v Rebuilt Fuser Assy.
- Paper Pick-up Roller
- Separation Pad
- Transfer Corona Assy
- New "Axial" exhaust fan.

It does not include the Ozone Filter (92295Q) which should be replaced at 50K pages. Printers not equipped with replaceable Ozone Housing should be updated by the CE using P/N RG1-1753-000CN

If the printers are LJIIID or LJIIID's the additional parts should be ordered:

- RG1-2499-000CN Upper Feed Roller Assy
- RG1-2500-000CN Lower Feed Roller Assy
- RF1-2548-000CN Lower Separation Pad
- RG1-1356-000CN Duplex Paper Alignment ("Oblique") Roller
- RG1-2498-000CN Duplex Guide Assy

Service Test Tool Boards

LaserJet II/III

This is a very useful tool, for the LJII/LIII LaserJets, which is installed into the DC Controller PCA at J210. An access plate can be found and this is located on the RHS of the printer on the bottom cover pan. Its Part Number is:

33440-67905 Service Test Tool

This test board allows the CE to check the following visually (LED):

- * +5Vdc & -5Vdc Power Supply
- * +24AVdc Power Supply
- * DBAC (presence of the Developer AC Bias enable line)
- * DBDC (presence of the Developer DC Bias enable line)
- * PRIMARY (presence of the Primary Corona enable line)
- * TRANSFER (presence of the Transfer Corona enable line)

This tool additionally allows user to print the following print samples:

- * *White Page* This is useful for detecting light leaks, toner spills, defective EP Drums, primary corona failures, etc
- * *Vertical Lines* Useful for measuring skew, detecting scanner motor speed problems (lines will be wavy).
- * *Horiz Lines* Useful for measuring horizontal skew, detecting paper motion problems (lines will be wavy).
- * *Black Pages* Useful for detecting white spots, drop outs, drum defects, transfer system problems, etc.

It also has a READY INHIBIT switch which allows:

- * No paper in the paper trays
- * Non Paper tray
- * No EP Cart installed
- * Beam Detect ignored
- * Paper Jams are ignored.

All in all a very good diagnostic Tool

LJIIID/LJIID

Part Number 33447-67906

This tool does all the above functions, but additionally provides visual indication the following solenoids enabled and Photo-Sensors operating:

- | | |
|-----------------------------------|---|
| * SL301 (Upper Paper Feed Clutch) | * PS2 (Lower Motor Clock) |
| * SL1 (Lower Paper Feed Clutch) | * PS4 (Switchback Paper sensor - Paper Jam) |
| * SL302 (Registration Clutch) | * PS5 (Vert Reg Assy "Home" Position) |
| * SL7 (Switchback Deflector) | * PS301 (Upper Tray - Paper Out) |
| * SL5 (Switchback Drive Control) | * PS302 (Upper Tray - manual Feed) |
| * SL6 Switchback Directional) | * PS1 (Lower Tray - Paper Out) |
| * SL3 (Vert Reg Guide Roller) | * PS6 (Lower Tray - Manual Feed) |
| * SL2 (Duplex Drive Roller) | * PS3 (Dup Roller Sensor - Jam Detection) |
| * SL4 (Vert Reg Guide Assy) | * PS331 (Exit Sensor - Jam Detection) |

LJII/III DC Power Supply / Error 12 Troubleshooting

With Error 12, No Display, Dead & Power Supply problems on the LJII, LJIII, LJIID & LJIIID printers use the flow diagram below to help isolate the problem. Do NOT jump to cause, use a logical troubleshooting for the more difficult types of this problem. Error 12 means the Top Lid is open or the +24v is missing. Use this process to ascertain why the +24v is not present.

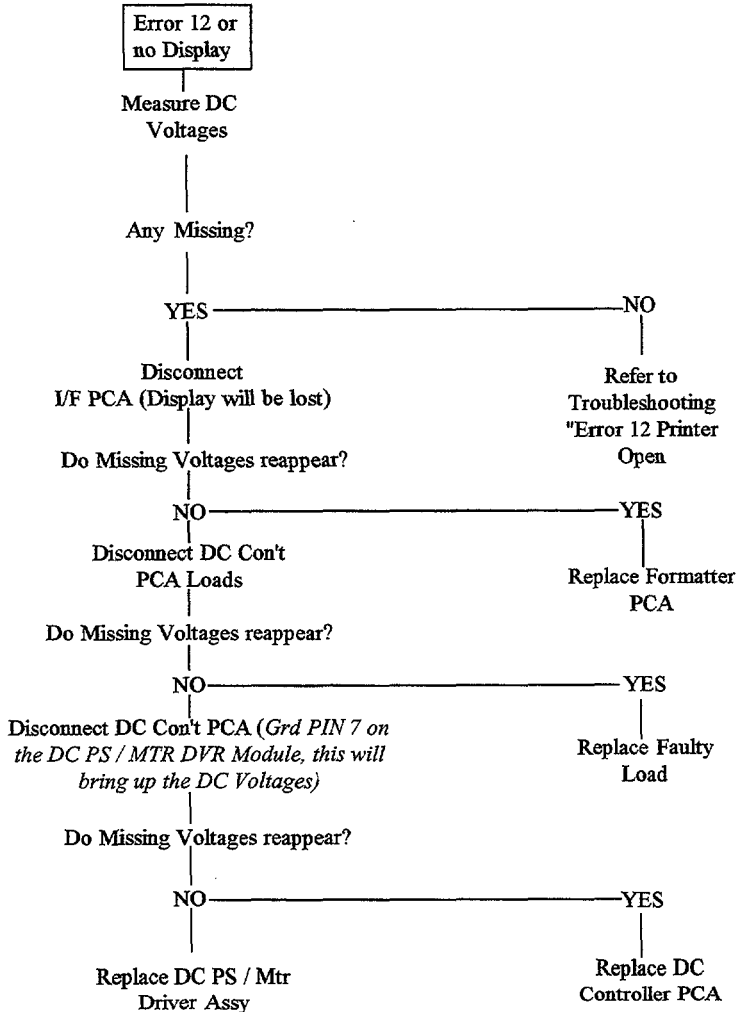

LJII/III/IIID/IIID - FAULTS WITH ERROR NUMBERS

Please note for all *Paper Jams* or *ERROR 13* problems, refer to *Paper Path* part of this section of this manual.

| | |
|--|--|
| <p><i>LJIII</i> after "Paper Source Error" such as "PC LOAD LETTER" other users on local network cannot use this printer until message is cleared. <i>This is NOT a problem with the LJII.</i></p> | <p>Customers who have many LJII's on local networks & then purchase LJIII's notice when one of the users selects an incorrect paper size, all other users of this LJIII are unable to print on it until the printer is manually reset. <i>This is NOT true for the LJII.</i></p> |
| <p>"PC LOAD A4" , continuous after power is applied to printer. <i>(Ger O'Mathony - Dublin)</i> <i>(New Info) (LJIII)</i></p> | <p><i>Replace Formatter PCA.</i></p> |
| <p>"UC TRAY EMPTY" all the time? (<i>LJII</i> / <i>LJIIID</i>)</p> | <ol style="list-style-type: none"> <i>1. Replace Paper Control PCA.</i> <i>2. Replaced DC Controller.</i> <i>3. Replace size sensor PCB (RG9-0605-000CN).</i> |
| <p>"UC LOAD A4" message continuously? Also, if the "CONTINUE" button was pressed the printed image was smaller than it should be? <i>(New Info) (LJIIID)</i></p> | <p>This problem occurred on the Upper tray, but could have equally occurred on the LJII/LJIII or LJIIID. Two blocks on the LHS & the RHS had broken off. This allowed the cassette tray to be inserted too far, causing incorrect tray size info to be sent to the DC Controller PCA. These Blocks do NOT show up in Service Manual on Page 8-45, item 1. It shows main body assy only, not these blocks. These blocks have the following P/N: (RA1-3917-000CN) <i>LHS</i> (RA1-3913-000CN) <i>RHS</i></p> <ol style="list-style-type: none"> <i>1. Replace these blocks.</i> |
| <p>WAITING FOR "02" Forever?</p> | <ol style="list-style-type: none"> <i>1. Disconnect I/F cable, is fault still apparent. Badly wired I/F cables have caused problems and normally shows up on Centronics cables. Typically pin 36 is grounded causing the problem.</i> <i>2. Replace I/F.</i> |
| <p>"05 SELF TEST" message appears intermittently either whilst printer is idle or when printing? <i>(LJIIID - Feb 95)</i></p> | <p>This problem was caused by the cable running by lower fan rubbing and wearing, then shorting one of the DC Power supplies voltages to ground. <i>Simply insulating the bared cable and re-routing resolved this problem.</i></p> |
| <p>Intermittent ERROR 12</p> | <ol style="list-style-type: none"> <i>1. Replace AC Power assy</i> |
| <p>ERROR 12, 55, 64 & 67</p> | <ol style="list-style-type: none"> <i>1. Replace HVPS.</i> |

LJII/III/IID/IIID - FAULTS WITH ERROR NUMBERS(Con't)

| | |
|--|--|
| <p>ERROR 12 or 55's</p> | <ol style="list-style-type: none"> 1. <i>Check Jumper J209 is connected on DC Cont PCA</i> 2. <i>See Service Note 33440AB/AU-09 when connected to a Vectra.</i> |
| <p>ERROR 12, 110v printer used with step down transformer. Printer would power up, as LJIII began to take load a "Clicking" noise was heard and printer exhibited Error 12.</p> | <p>Customer was using a small variable transformer that obviously could not supply the current the printer required. <i>Customer to ensure the transformer can supply the necessary current to the LaserJet.</i></p> |
| <p>ERROR 12 or no Display (LJII)</p> | <ol style="list-style-type: none"> 1. <i>Replace the DC Controller PCA. (See S/N 33440AB/AU-09 if used with Vectra)</i> 2. <i>Replace Formatter PCA.</i> 3. <i>Replace DC Power Supply.</i> 4. <i>Replace Scanner Motor.</i> 5. <i>AC Power Module.</i> <p>See Error 12 flow diagram at end of this section Appendix A1.</p> |
| <p>PERMANENT ERROR 16 "Toner Low".</p> | <ol style="list-style-type: none"> 1. <i>Grey wire from HVPS sub-block to HVPS was connected to lower position instead of upper position.</i> 2. <i>Replace HVPS</i> 3. <i>Replace HVPS to DC Controller cable (P/N RG1-0906-000CN)</i> 4. <i>Replace DC Controller PCA.</i> |
| <p>ERROR 20 Memory Overflow</p> | <p><i>Downloading too many soft-fonts/graphics. Initiate a "Print Font" and work out how much memory this takes compared to the memory actually available. Reference "Programming Hints in Tech Ref Man. Standard User Memory is 395Kb.(LJII)</i></p> |
| <p>When continuous Self-Test '04' is used on PLC 5 printers ERROR 20 may occur. (LJIII / IIID)</p> | <p><i>This is normal for PCL5 printer, NOT PCL4. Due to HPGL2 vector commands used on Self-Test and the additional memory it requires. The number of pages of Self-test which are printed before this error may occur depends on the available RAM. If printer is powered down more RAM may be available, therefore ERROR 20 may take longer to appear. No remedial actions is required to correct this problem.</i></p> |
| <p>ERROR 41 (Intermittent) (LJII)</p> | <ol style="list-style-type: none"> 1. <i>See Service Note 33440A-09 concerning Error's 41,50,51 & 52. Replace Laser/Scanner cable RG1-0908-000CN</i> 2. <i>Check grounding bushing on LHS of Reg assy. Especially when replacing Reg Assy, ensure this brass bushing is orientated correctly. This(Cont)</i> |

LJII/III/IIID/IIID - FAULTS WITH ERROR NUMBERS (Con't)

| | |
|---|--|
| | <p align="center">brass part helps eliminate static.</p> <p>3. <i>Replace DC Controller PCA.</i> The printer only failed intermittently 1st thing in morning on power on.</p> <p>4. <i>Replace Optics Assy.</i></p> |
| <p>ERROR 41 very Intermittent. OK on long continuous print runs, fails on 1 or 2 page prints (short print files). (K. Batchelor - Hatfield)</p> | <p>Could hear Scanner Motor audibly noisy, <i>replaced Scanner Motor</i>, also in this case <i>the DC Controller PCA was replaced</i> as well.</p> |
| <p>Very Intermittent ERROR 41. Replaced all normal parts, CE noted that an Error 12 occurred first, then Error 41.</p> | <p><i>Replace DC Power Supply</i></p> |
| <p>THIN LINES across page intermittently, can be associated with intermittent Error 41, 51 & 52's</p> | <p><i>Replace RG1-0908-000CN Laser/Scanner cable</i></p> |
| <p>ERROR 50's NOTE wait 7 minutes for error to clear or S/C the following capacitors on the respective LJ's - <i>LJII = C211; LJIID = C216; LJIII/LJIIID not known</i></p> | |
| <p>ERROR 50? (LJII)</p> | <p>1. <i>Replace cable J206 DC Cont to J331 on Fuser Exit PCA (P/N RG1-0907-000CN).</i> See Service Note 33440A-09 or 33440AU-01</p> <p>2. <i>Replaced Fuser Assy.</i></p> <p>3. <i>Replace DC Controller PCA.</i></p> <p>4. <i>Replace AC Power Module.</i></p> <p>5. <i>Replace RG1-0912-000CN AC Power Module Cable</i></p> |
| <p>Intermittent ERROR 50, can be associated with paper jams.</p> | <p>1. <i>Replace RG1-0907-000CN Fusing Assy cable</i>, these are known to be intermittent. See Service Note 33440A-09</p> <p>2. <i>Replace AC Power Module Cable RG1-0912-000CN.</i></p> |
| <p>ERROR 51 (LJ2/3/2D/3D)</p> | <p><i>Replaced EP Cartridge</i> (customer was using refilled)</p> |
| <p>When printing, the FIRST PAGE was "BLANK" and then ERROR 51 occurred.</p> | <p>1. Check cable from DC Controller PCA is <i>fully inserted into connector at Optics Assy. (J401)</i></p> <p>2. <i>Replace DC Controller PCA.</i></p> <p>3. <i>Replaced Optics to DC Controller Cable. (RG1-0908-000CN)</i></p> |

LJII/III/IIID/IIID - FAULTS WITH ERROR NUMBERS (Con't)

| | |
|--|---|
| <p>ERROR 51 intermittently <i>(Mike Duthie-Aberdeen)</i> <i>(New Info) (LJIID)</i></p> | <p>Trying normal parts did not fix this problem. It was noticed that the customer was extremely gentle when closing down the lid. Whereas the CE was not so dainty when shutting the lid. <i>Adjustment of the hinges and locking mechanism resolved problem.</i> It was believed that the Laser Shutter was not opening fully. <i>This fault occurred on a LJIID.</i></p> |
| <p>Intermittent ERROR 51 <i>(Frank Dasilva / London)</i> <i>(New Info)</i> <i>(LJIID)</i></p> | <p>On power up ERROR 16 (Toner Low) occurred, Main motor turned. When print command was received by printer (in this case a LJIID) the I/P feed solenoid was heard to fire, no paper movement, then ERROR 51. <i>Replacing DCPS Assy resolved problem.</i></p> |
| <p>ERROR 53 (LJIID) Memory Incompatibility problem? <i>(Dave Wassell - B'stoke)</i> <i>(May 94)</i></p> | <p>No fault if memory deinstalled from printer. CE replaced 1Mb (33443-69001) (Rev B) memory bd, replaced Formatter PCA & DC Power Supply. <i>To resolve this problem the Formatter and 1Mb memory PCA's were replaced as a pair.</i></p> |
| <p>Intermittent ERROR 51 / 52's</p> | <ol style="list-style-type: none"> 1. <i>Replaced Cable (RG1-0908-000CN) from Laser Scanner Unit (J451) to DC Controller (J202/203)</i> <i>See Service Note 33440A-09.</i> 2. <i>Replace Laser Scanner Unit.</i> |
| <p>ERROR 52 , a blank page moves through printer.</p> | <ol style="list-style-type: none"> 1. <i>Scanner Motor cable NOT connected correctly (J401) to Optics Assy. Reseated this cable..</i> 2. <i>Replace Laser/Scanner cable RG1-0908-000CN</i> |
| <p>ERROR 55?</p> | <ol style="list-style-type: none"> 1. <i>Replace Formatter PCA.</i>(See S/N 33440AB/AU-09 if connected to a Vectra). 2. <i>Replace DC Controller PCA.</i> 3. <i>Replace DCPS Assy.</i> 4. <i>Replace Formatter & DC Controller PCA's as a pair.</i> |
| <p>ERROR 55? Only when Post-Script Cart's (33439P/Q) are installed. (LJIII only)</p> | <p>When some HP PostScript cartridges (33439P/Q) are installed in a LJIII, the printer completes Self-Test and then locks-up in the start-up page. The main motor starts, but paper is never picked from the paper tray. Error 55 may be displayed if the printer is powered on for more than 3 minutes. This situation only occurs with LJIII's that have the newer DC Controllers (P/N RG1-2706-000CN). The exchange PCA (33449-69004) is NOT affected by this problem. <i>The PS Cart's must be exchanged with another with a DC of 3150 and may have a blue dot on its shell. See service Note 33439P-01 or 33439Q-01 for further detail.</i></p> |

LJII/III/IIID/IIID - FAULTS WITH ERROR NUMBERS (Con't)

| | |
|--|---|
| <p>ERROR 55 or 64 or 67 or 12</p> | <p>1. Replace HVPS.</p> |
| <p>ERROR 55 or 12</p> | <p><i>1. Check Jumper J209 is connected on DC Con PCA. 2. See Service Note 33440AB/AU - 09 when connected to a Vectra.</i></p> |
| <p>ERROR 63</p> | <p><i>1. Faulty Expansion Memory PCA. 2. Using Non HP Memory.</i></p> |
| <p>ERROR 67 when print command is received by Formatter PCA. <i>(New Info)</i> <i>(N Donaldson - SQF)</i> <i>(New Info)</i></p> | <p>If Formatter PCA is disconnected the print engine test does run OK. <i>Replacing DCPS assy fixed this problem.</i> Other causes for this error are: <i>1. Replace Formatter PCA</i></p> |
| <p>Intermittent ERROR 67? <i>(New Info)</i></p> | <p><i>1. Replace Formatter PCA. 2. Replace HVPS Assy.</i></p> |
| <p>ERROR 70 When downloading soft-fonts <i>(LJIID)</i></p> | <p><i>Not enough memory!</i></p> |
| <p>ERROR 79</p> | <p><i>1. Non HP Font cartridge caused problem 2. Non HP Memory 3. Faulty Formatter PCA. 4. Faulty HP Memory or Font. 5. Check any boards installed in Optional I/O slot, e.g. Network, i-Data boards, etc.</i></p> |
| <p>ERROR 79 (01ae) <i>(LJIID)</i></p> | <p>Only fails in Duplex mode, using none HP font, normally on one particular programme. Programme works fine on LJ2000. Problem caused by undefined char from a char-font, normally treated as a "space", in this case it does not. <i>Solution, do not use these none HP-fonts on HP LJ printers..</i></p> |
| <p>ERROR 79 Customer using HPGL2 commands and getting this error mid-print? <i>(Mike Duthie-Aberdeen)</i> <i>(New Info) (LJIII)</i></p> | <p>All the normal parts were replaced, Formatter, memory, driver, etc without resolving the problem. <i>By changing from internal font 12 to printer default, it provided the solution to this problem?</i></p> |

LJII/III/IID/IIID - MISCELLANEOUS

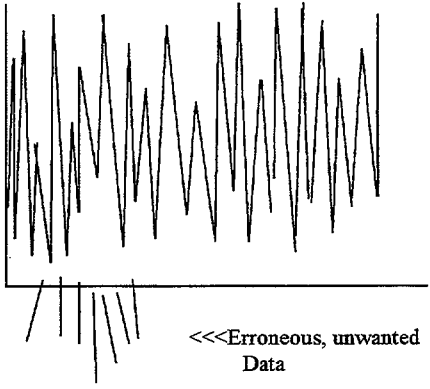
| | |
|---|--|
| <p>DELAMINATION of the rear side of page near the leading top edge. There can be two marks which are in line with the two eccentric cam rollers mounted on the I/P Pick-up Assy. The problem can be intermittent.</p> <p style="text-align: center;"><i>(Updated Info)</i></p> <p style="text-align: center;"><i>(LJII / III / IID / IIID)</i></p> | <p>This problem can occur on LJII/III/IIID & IIID's.</p> <ol style="list-style-type: none"> 1. <i>Changing media to a Laser Quality paper</i> that adheres to the Paper Spec's Guide always resolves this problem. 2. <i>Replace both the Separation Pad & I/P feed Assy.</i> 3. If customer is NOT using extremely light or heavy paper (16lb or 36lb), <i>remove one of 2 tension spr'gs (P/N RA1-3871-000CN) on Reg Assy.</i> Remove the spring on the side that delamination occurs. DO NOT remove both springs. <i>(Supported by Div)</i> 4. If 1 & 2 do not work for you, try this <u>unsupported</u> method. <i>Remove high spot off the 2 eccentric cams these cams are part of the I/P feed Assy.</i> <p>NOTE: If the paper is of extremely poor quality items' 2, 3 & 4 may not help at all.....</p> |
| <p>Eroneous lines appearing on XY Chart, printing in HPGL2, see example opposite. The problem appears the more complex the XY Chart plot is.</p> <p style="text-align: center;"><i>(LJIII)</i></p> | <ol style="list-style-type: none"> 1. Use latest revision of firmware (DC 19900430) on the Formatter PCA.  <p style="text-align: right;"><<<Erroneous, unwanted Data</p> |
| <p style="text-align: center;"><i>LJIII Intermittently drops OFF-LINE?</i></p> <p style="text-align: center;"><i>(G. Clark - Leeds - Jan 94)</i></p> | <p style="text-align: center;"><i>Replacing Formatter PCA seem to resolve this pfm.</i></p> |
| <p>COMPLETELY DEAD? No Display, ERROR 12, this fault could be Intermittent.</p> <p style="text-align: center;"><i>(Updated)</i></p> | <ol style="list-style-type: none"> 1. <i>Replace DC Controller PCA.</i> 2. <i>Replace Formatter PCA</i> 3. Remove any PCA installed in the Optional I/O (JetDirect XIO, i-Data, etc), is fault resolved? If not <i>replace this PCA..</i> 4. <i>Replace DC Power Supply.</i> If the DC Controller & Formatter PCA are removed you can check DCPS by grounding pin 7, <i>Remote Enable line</i>, on the DC Power Supply, if the supply is OK the +/- 5v & 24v should come up. If not replace DC Power Supply Module. <p><i>See Flow Diagram towards beginning of this section</i></p> |

LJII/III/IIID/IIID - MISCELLANEOUS (Cont)

| | |
|---|---|
| <p>Display goes Blank for very short periods of time? Then OK (Andy Buddle - Leeds) (New Info)</p> | <p>Top lid switch was found to be momentarily opening causing this intermittent problem. <i>Replacing DCPS assy resolved this problem.</i></p> |
| <p>Intermittently goes DEAD? (Bill Baigrie - SQF)</p> | <p><i>Replace DC Power Supply.</i></p> |
| <p>Intermittently goes DEAD or loses DISPLAY? (LJIIID) (John Holmes - Gatwick) (New Info)</p> | <p>All normal parts were replaced for this fault, but problem still prevailed. A Mains Monitor was installed and <i>highlighted 900v peaks between neutral & earth.</i></p> |
| <p>FRONT PANEL DEAD, DC Power still active, fans running?</p> | <p><i>1. Replace Operator's Front Panel PCA. 2. Replace Formatter PCA.</i></p> |
| <p>DATA LOSS or GARBLED data on Centronics port? CORRUPT DATA when Soft-fonts or downloaded. Normal text seems OK. This LJ was connected to an IBM PS2 using Centronics protocol.</p> | <p><i>See Service Note 33440A-1.</i> Use HP 24542D Centronics cable:</p> |
| <p>FRONT PANEL LED's ON ALL THE TIME</p> | <p><i>Replace AC Power Module.</i></p> |
| <p>SELF-TEST Will Not Run? All Front Panel LED's on.</p> | <p><i>Replace I/F PCA.</i></p> |
| <p>Fuser Assy making a "SQUEAKING NOISE"</p> | <p><i>See Service Note 33440AU-02.</i> A vibration proof pad at LH end of Fusing Assy becomes completely dry of lubricant, thus making this noise. Lubricate with CK-0544-000CN. This will apply to ALL LJ's using this print engine.</p> |
| <p>NOISY, Squealing, Chirping. (LJII Only)</p> | <p>The Upper Cooling fan brass bushing lubrication is drying-up? Sometimes this fan may seize. See Service Note 33440A-11, <i>with fan assy RH7-1047-000CN simply replace the bushing and the bushing holder ONLY.</i> Please note, the LJII/IIID use RH7-1074-000CN fans. These models CANNOT use these replacement parts.</p> |

LJII/III/IIID/IIID - MISCELLANEOUS (Cont)

| | |
|---|--|
| <p>NOISY when Main Motor turns on? (LJIII / IIID) <i>(Andy Suett)</i> <i>(New Info)</i></p> | <p>When motor turns it makes a loud grinding noise, very similar to gear meshing problems. All mechanical parts were replaced. <i>Replacing the DC Power Supply fixed this problem in the LJIII & LJIIID.</i> This could occur on the LJII & LJIIID printers.</p> |
| <p>NOISY when Main Motor turns on? (LII/III/IIID/IIID) <i>(Hans Hjertquist - Boise)</i> <i>(New Info)</i></p> | <p>This failure can occur with the use of <i>NON-HP Toner Cartridges</i>. Some of these cartridges use material in their drum drive gears that is incompatible with materials used in the LJ drive gears. The result is aggravated wear and results in <i>premature failure of the LJ drum drive gear P/N RSI-0105-000CN.</i></p> |
| <p>Grinding NOISES? (LJIII) <i>(A. Cowie - Leeds - Sept 94)</i></p> | <p><i>Replacing Lower Fan resolved this problem.</i></p> |
| <p>EXCESS TONER depositing inside printer?</p> | <p>Developer Bias constantly ON, due to a S/C on ribbon cable J211 between 6 and 7(DC Controller to HVPS cable.) <i>Replace P/N HVPS Cable RG1-0906-000CN</i></p> |
| <p>Print "CRACKING" when paper is folded. White lines may be seen running through characters where page is folded.</p> | <p>Toner comprises of pigmented plastic material and iron oxide. When subjected to high temperatures these individual plastic particles become part of a larger plastic image on the page. When the page is folded the plastic must give in some way. If the print image is well set into the paper , the resulting break in the plastic will NOT be very apparent. However, if the toner has NOT been able to penetrate the paper fibres, the "Crack" in the plastic image will be amplified. A white line will be seen through image. To Minimise:</p> <ol style="list-style-type: none"> 1. <i>Ensure paper meets ALL Paper Specs, see guide 5002-1801. In particular pay attention to the smoothness (100-250 Sheffield) and/or "Wax Pick" (>11 Dennison)</i> 2. <i>A lighter Density setting will ensure less toner used, thus minimising problem.</i> 3. <i>A lighter character stroke may also help</i> |
| <p>LJIII after "Paper Source Error" such as "PC LOAD LETTER" other users on local network cannot use this printer until message is cleared. This is NOT a problem with the LJII.</p> | <p>Customers who have many LJII's on local networks & then purchase LJIII's notice when one of the users selects an incorrect paper size, all other users of this LJIII are unable to print on it until the printer is manually reset. This is NOT true for the LJII.</p> |

LJII/IIII/IIID/IIID - MISCELLANEOUS (Cont)

| | |
|--|--|
| <p>NO STATUS Request Info Returned by printer. Connected to 3000. (LJII / III / IIID)</p> | <p>The LJIIID and later were unable to respond to status requests (Esc ?, DCI). The Optional Status Read board, (26013A) plugs into the Optional I/O slot, provides the status readback. This allows the LJIIID, LJIII & LJIIID to be connected to a 3000. Term-type 26 is recommended. <i>Install 26013A into Optional I/O slot to resolve this problem.</i></p> |
| <p>I/O Protocol changes from CENTRONIC's to Factory Default SERIAL? (New Info)</p> | <p>Power Fails may cause this problem. LJIII / IIID's may be susceptible to this problem due to power interruptions. <i>Ensure customer has a stable AC Power Supply.</i> Install Mains Monitor to check-out supply.</p> |
| <p>Optional I/O which was selected via the Front Panel returns to default Serial? (LJIII/IIID) (Anja Rabold - PGE) (New Info)</p> | <p><i>Ensure customer has stable AC Power Supply.</i> Install Mains Monitor to check-out supply.</p> |
| <p>CANNOT Configure PAGE PROTECT to Letter, Legal etc, size paper together with the OPTIONAL I/O. (LJIII / IIID) (New Info) (Hans Hjertquist - Boise)</p> | <p>If the Optional I/O cannot be selected with Page Protect try the following:</p> <ol style="list-style-type: none"> 1. <i>Initiate a 08 Cold Reset by depressing ONLINE whilst powering on printer.</i> 2. <i>Set Page Protect to the size of media required.</i> 3. <i>Initiate a 07 RESET by depressing the CONTINUE/RESET key for 5 seconds.</i> 4. <i>Cycle power to the printer.</i> 5. <i>Go to 2nd level menu, within this menu select I/O = OPTIONAL.</i> <p>NOTE: This procedure will reset to factory defaults, therefore prior to initiating above obtain copy of Self-Test with customers configuration.</p> |
| <p>Not FUSING correctly? (LJIII / IIID)</p> | <p>See Service Note 33449A-04 or 33459A-02, this describes a modification to DC Controller PCA to reduce the costs and involves the removal of Fuser switch (SW205). When ever this PCA is replaced the CE should pay particular attention to the presence or absence of SW205. A circuit trace MUST be cut if SW205 activating lever is not present.</p> |
| <p>Cannot OPEN TOP COVER when the release button is depressed. (LJIII)</p> | <p>See Service Note 33449A-03, open using tool like a hard flat piece of plastic, 3mm thick and broad enough to distribute a force across 3-4 cm of cover surface. (i.e. 3.5" disc). Place between top cover gap, near release button and pry open.</p> |

LJIIID / LJIIID - MISCELLANEOUS PROBLEMS

| | |
|--|--|
| <p>Customer was attempting to print the 1st side in Portrait & the 2nd page in Landscape? (Duplex Mode - LJIIID)</p> | <p><i>This is not Supported and cannot be done.</i></p> |
| <p>Does not Feed from Lower Tray & does not FUSE correctly? (LJIIID/IIID)</p> | <p><i>Replacing the DC Controller resolved the feed problem.</i> Note: The problem with <i>not fusing</i> was due to the fuser switch on DC Controller NOT installed correctly after the PCA replacement.</p> |
| <p>Not FUSING Correctly after replacing the DC Controller PCA. (LJIII / IIID)</p> | <p>Fuser switch SW205 has been removed from LJIII & LJIIID printer to reduce costs. When replacing DC Controller, note the presence or absence of this SW205 activating lever. If absence cut trace on new DC Controller PCA between SW205 pin 1 & R889. See Service Notes 33449A-04 or 33459A-02</p> |
| <p>Printed image on front side of page is always longer than the rear side in Duplex. (LJIIID / LJIIID)</p> | <p>The Duplex page is printed first with LJIII/IIID's, therefore side 2 passes through fuser first. The paper shrinks, then side 1 is printed next. This side goes through the fuser again. <i>In Total side 2 gets shrunk 2 times.</i> This is why the front side is longer than the rear side.</p> |
| <p>Paper BUCKLES as it comes up from the Duplexer. Also the print image SLIPS DOWN page by 25mm to 30mm (New Info) (Steve Marshall - Washington) (LJIIID)</p> | <p>The active signal to SL2 was LOW at all times. Therefore this feed mechanism was ON all the time. <i>This forced the paper to arrive earlier to the registration assy.</i> This caused the paper to buckle. If the paper manages to get through the Registration Assy the image has slipped down the page by 25 to 30mm. 1. Replace DC Controller 2. Replace SL" Duplex Drive roller Clutch Solenoid</p> |
| <p>Paper "DOG EAR's" using A5 size paper, fed from manual tray? (M. Brabyn - LJ3 - Jan 95)</p> | <p>The leading edge corners are bent back to give the so called "Dog Ear" effect. <i>This is caused by the deflector in the Fuser Exit area.</i> A5 paper just happens to coincide with 2 of these deflector pawls. As A5 paper is not supported the unofficial actions to try are: 1. Try 100grm paper straight through. 2. Displace manual feed guide on cassette tray cover, remove one screw & allow guides to move, then replace this screw. The disadvantage of this is the the printed image would have to be offset to compensate.</p> |

LJII/III/IID/IID - PRINT QUALITY PROBLEMS

| | |
|---|---|
| <p>Repetitive marks on paper, print defects appear at regular intervals (LJII / IID / III / IID)</p> | <ol style="list-style-type: none"> 1. 95mm apart (EP Drum) 2. 80mm apart (Upper Fuser Roller) 3. 65mm apart (Lower Fuser Roller) 4. 51mm apart (Toner Cartridge Developer Roller) 5. 44mm apart (Lower Reg Roller) 6. 38mm apart (Upper Reg Roller) 7. 13mm apart (Reg Assy Transfer Roller) |
| <p>BLANK PAGES? (Oct 94)</p> | <ol style="list-style-type: none"> 1. Empty EP Cart. 2. Sealing tape not removed from EP Cart. 3. Broken Transfer Corona (See S/N 33440A-6) 4. Are connections on EP cart & HVPS damaged, corroded, dirty or missing. 5. Replace HVPS or HVPS Cable to DC Controller. 6. EP Cart Drum not rotating. 7. Replace Laser/Scanner Assy or Laser/Scanner to Dc Controller cable. 8. replace DC Controller. 9. Bent top cover hinge brackets? |
| <p>WHITE or BLANK pages</p> | <ol style="list-style-type: none"> 1. Replace Transfer corona? See Service Note 33440A-6 (Disconnect Pink sleeved wire on HVPS to ascertain if image is on the drum) 2. Top hinge badly bent, no mechanical connection to drum from the main gear train. <i>Replaced the two lid hinges.</i> 3. Replace DC Cont PCA, Not turning on HV system, use Service Tool PCA to verify LED on. 4. Replace LJ Drum Drive gear RSI-0105-000CN. |
| <p>When printing the FIRST PAGE it was "BLANK" and then ERROR 51 occurred.</p> | <ol style="list-style-type: none"> 1. Check cable from DC Controller PCA is <i>fully inserted into connector at the Optics assy. (J401)</i> 2. Replace DC Controller PCA. 3. Replaced Optics to DC Controller Cable. |
| <p>BLANK column down page, approx 6cm from RHS and 1cm wide. DUPLEX ONLY (Dave Wassell - S'ton)</p> | <p><i>Replace Transfer Corona</i></p> |
| <p>BLANK Page? (LJIII) (Steve Oakes - Cheadle) (New Info)</p> | <p>EP Cartridge Drum Moving, due to damaged printer <i>Drum Drive gear RSI-0105-000CN</i>. This is internal to the LJ, not part of EP Cartridge. Aggravated wear of this gear can be caused by the use of NON-HP Toner Cartridges (Refilled). <i>Replace this gear.</i></p> |
| | |

LJII/III/IV/IIID - PRINT QUALITY PROBLEMS (Con't)

| | |
|--|--|
| <p>BLACK Pages printed? (Oct 94)</p> | <ol style="list-style-type: none"> 1. <i>Repace EP Cart.</i> 2. <i>Check connections on EP Cart & HVPS connector.</i> 3. <i>Replace HVPS or HVPS to DC Controller cable.</i> 4. <i>Replace Laser/Scanner assy or Laser/Scanner to DC Controller PCA cable.</i> |
| <p>Random Horizontal BLACK Lines? (Oct 94)</p> | <ol style="list-style-type: none"> 1. <i>Defective or improperly seated Fibre Optics cable.</i> 2. <i>Replace Laser/Sanner assy.</i> 3. <i>Replace DC Controller PCA</i> 4. <i>This applies to LJII & III ONLY, Replace Laser/Scanner cable RG1-0908-000CN</i> |
| <p>THIN LINES across page intermittently, can be associated with intermittent Error 41, 51 & 52's.</p> | <p><i>Replace RG1-0908-000CN Laser/Scanner cable. See Service Note 33440A-09</i></p> |
| <p>Many BLACK Horizontal lines down page? (LJIIID - Feb 95)</p> | <p>Some of these horizontal Black lines were pencil this others were approx 1mm wide. In some examples these had lines across page which appeared all down the page. In other examples only a few lines appeared. <i>Replacing the Laser/Scanner to DC Cont PCA cable resolved pbm.</i></p> |
| <p>Vertical White Streaks (Oct94)</p> | <ol style="list-style-type: none"> 1. <i>Empty Toner Cartridge.</i> 2. <i>Dirty Transfer Corona</i> 3. <i>Dirty Beam-to-Drum Mirror.</i> 4. <i>Replace Laser/Scanner assy</i> |
| <p>THIN Vertical DARK Black Streaks? (Oct 94)</p> | <ol style="list-style-type: none"> 1. <i>Dirty Primary Corona Wire.</i> 2. <i>Check/replace for scratches on EP drum.</i> 3. <i>Check/replace Fuser rollers & cleaning pad.</i> |
| <p>BLACK LINE down RHS of sheet.</p> | <p>Clean Corona in EP Cartridge with Cleaning Tool. Angle tool to get to extreme right hand edge of the corona wire cleaning slit. <i>This problem has been resolved by extending this slit on the RHS of the. Toner cartridge. This was implemented some time ago.</i></p> |
| <p>Pencil Thin BLACK LINE down page, appears on Text sent from host or Self Test or Print Engine Test. May be difficult to see on Print Engine Test, the line will appear bolder. (LJIII)</p> | <p><i>Replace Formatter PCA.</i></p> |

LJII/III/IIID/IIID - PRINT QUALITY PROBLEMS (Con't)

| | |
|---|---|
| <p>THIN Line down page, it appeared approx 3 inches (75mm) from RHS of page. <i>(Tony Griffiths - B'ham)</i></p> | <p>Heavy media was causing problem (110 grms), using 90 gm paper resolved problem.</p> |
| <p>BLACK STRIPE on RHS of Page? <i>(Oct 94)</i></p> | <p>Dirty Primary Corona in EP Cartridge. <i>1. Clean this wire of replace EP Cartridge.</i></p> |
| <p>On all BLACK page, at 6 lpi, WHITE horizontal lines at intervals of 50mm appeared down the page. These ALWAYS appear in exactly the same place on the page. However at 7 & 8 lpi it is OK? <i>(LJIII)</i></p> | <p><i>In this case the FORMATTER PCA replacement fixed this problem.</i> Customer Original which failed: 33449-60001, Rev A Kit PCA which fixed problem: 33451-69001, DC 3040</p> |
| <p>BACKGROUND? <i>(Oct 94)</i></p> | <p><i>1. Set Print Density towards "1" to minimise background.</i> <i>2. Media out of Spec.</i> <i>3. Is Printer very dirty inside? Clean.</i> <i>4. Dirty Primary Corona, clean.</i> <i>5. Replace EP Cartridge.</i></p> |
| <p>BANDS of BACKGROUND Normally down page only where characters are printed. Simplex OK, 2nd page of Duplex shows this problem.</p> | <p><i>1. Check quality of paper.</i> <i>2. Replace Transfer Corona.</i></p> |
| <p>GREY BACKGROUND</p> | <p><i>Caused by unsupported media, shows up particularly well on envelopes.</i></p> |
| <p>GHOSTING OF CHAR's Only very slightly in the top LH corner of page. <i>(LJIID)</i></p> | <p><i>Replace Transfer Corona.</i></p> |
| <p>ONE COLUMN DARKER or SLIGHT GHOSTING, 2 inches from LHS of page.</p> | <p><i>Replace Transfer Corona.</i></p> |
| <p>FAINT PRINT? <i>(Oct 94)</i></p> | <p><i>1. Empty Toner Cart?</i> <i>2. Adjust Print Density.</i> <i>3. Media out of Spec.</i> <i>4. Dirty Transfer Corona, Clean or replace.</i> <i>5. Replace HVPS.</i></p> |

LJII/III/IIID/IIID - PRINT QUALITY PROBLEMS (Con't)

| | |
|---|---|
| <p>FAINT PRINT & LOSING HALF OF CHAR's on RHS.</p> | <p><i>Replace EP Cartridge.</i></p> |
| <p>Parts of print MISSING or White area's where text should be, typically at the edges of the page? <i>(New Info)</i> <i>(LJII / IIID / III / IIID)</i></p> | <p>The toner cartridge installation label which is attached to the Mirror Shutter Assy inside the hinged lid of LJ had become detached and was interfering with the laser beam on its passage to the EP Drum. This problem could occur on any of this printer family. Remove offending label.</p> |
| <p>RHS Text MISSING or may be DISTORTED <i>(Oct 94)</i></p> | <ol style="list-style-type: none"> 1. <i>Empty EP Cart.</i> 2. <i>Bean-to-Drum Mirror is bent or misaligned.</i> 3. <i>Bent Top Cover Assy Hinge Brackets.</i> |
| <p>WAVEY Print? <i>(Oct 94)</i></p> | <p><i>Replace Laser/Scanner assy</i></p> |
| <p>Intermittent POOR PRINT QUALITY when printer is cold. Text appears fuzzy?</p> | <p><i>Replace Scanner Assy.</i></p> |
| <p>COMPRESSED Characters.</p> | <p><i>Faulty EP Cartridge.</i></p> |
| <p>Text appears SMEARED With BLACK BLOTCHES. These blotches appear to be 3.7 inches apart running down the page.</p> | <ol style="list-style-type: none"> 1. Replace HVPS (J601) to DC Controller (J211) cable. (RG1-0908-000CN) 2. Replace DC Controller. <i><u>THIS FAULT CAN BE SEEN USING SERVICE TOOL PCA. PRIMARY CORONA PERMANENTLY SWITCHED ON</u></i> |
| <p>SMUDGES on back side of page, EXCESSIVE toner built up around corona, 94mm Repetitive print defect that appears on contiguous pages, Yellowing & deterioration of internal components may occur. SMUDGES down page, this occurs on page 2 which is the first page to be printed <i>(LJIIID)</i> <i>(New Info)</i></p> | <p><i>Replace RG1-0906-000CN High Voltage Cable. See Service Note 33440A-09</i></p> <p>This problem exhibits itself as "scallops" down the page. These "scallops" are similar to horseshoes or letter "u" rotated 90 degrees to the norm.</p> <ol style="list-style-type: none"> 1. <i>Clean Static Teeth.</i> 2. <i>Replace Transfer Corona.</i> |
| <p>SMUDGED ON 3rd LINE of PRINT?</p> | <p><i>Caused by a "BDT 6 Bin Sheet Feeder" (None HP sheet feeder attachment to the LJ). It can easily be cleared by disconnecting the Sheet Feeder testing LJ as a stand-alone printer.</i></p> |

LJII/III/IID/IHD - PRINT QUALITY PROBLEMS (Con't)

| | |
|---|---|
| <p>SMUGGED Band with Over-Print? (Oct 94)</p> | <p><i>Worn Feed Rollers Assy and Separation Pad.</i></p> |
| <p>SMUDGES down page, this occurs on page 2 which is the These first page to be printed (<i>LJIID</i>) (<i>New Info</i>)</p> | <p>This problem exhibits itself as "scallops" down the page. These "scallops" are similar to horseshoes or letter "u" rotated 90 degrees to the norm. <ol style="list-style-type: none"> <i>1. Clean Static Teeth.</i> <i>2. Replace Transfer Corona.</i> </p> |
| <p>After long periods of alternate printing from Envelope Tray, Upper Tray, then Lower Tray DARK Background SMUDGES appears in the Upper middle part of page. Replacing with NEW EP Cartridge appears to fix problem for a short period of time and then returns. (<i>LJIID/LJIID</i>)</p> | <p>The combination of envelopes and paper used in the Upper Tray caused this problem. <i>Selection of improved quality envelopes and paper reduced problem dramatically.</i></p> <p>Note: By leaving the faulty EP Cart's in box or dark cupboard, they will recover and will be usable again.</p> |
| <p>37mm Smear problem, a smear manifest itself on A4 paper 37mm from the bottom of the page. The text at this point appears "bold" when compared to the rest of the print.</p> | <p><i>Replace Registration Assy.</i></p> |
| <p>PRINTS INVERSE VIDEO</p> | <ol style="list-style-type: none"> <i>1. DC Controller PCA.</i> <i>2. Replace HVPS.</i> |
| <p>EXCESS TONER deposited print engine?</p> | <p>Developer Bias constantly ON, due to a S/C on ribbon cable J211 between 6 and 7 (DC Controller to HVPS cable.) <i>Replace RG1-0906-000CN HV cable.</i></p> |
| <p>Faulty Registration (Oct 94)</p> | <ol style="list-style-type: none"> <i>1. Worn Feed Roller Assy</i> <i>2. Replace Registration Assy</i> <i>3. Check or Replace faulty Cassette Tray.</i> <i>4. Out of Spec media?</i> |
| <p>IMAGE SKEWED? (Oct 94)</p> | <ol style="list-style-type: none"> <i>1. Ensure paper & Paper Tray are installed correctly.</i> <i>2. Replace worn Feed Roller Assy.</i> <i>3. Replace Registration Assy.</i> <i>4. Is the Fuser Insulator Pad Missing?</i> |

LJII/III/IIID/IIID - PRINT QUALITY PROBLEMS (Con't)

| | |
|---|--|
| <p>FIRST LINE of characters SLIPPING DOWN PAGE slightly.</p> | <ol style="list-style-type: none"> 1. <i>Registration Solenoid sticking, replace.</i> 2. <i>Replace Paper Control PCA.</i> |
| <p>IMAGE Moving DOWN page? (LJII) (S. Davies - Cheadle - July 94)</p> | <p>When printing Self-Test, prints 1st page OK, 2nd page image moves down page 5mm and every following page begins printing at this point. <i>Replacing Paper Control PCA resolved this pbm.</i></p> |
| <p>Character VOIDS / POOR FUSING? (Oct 94)</p> | <ol style="list-style-type: none"> 1. <i>Try setting Print Density toward "9".</i> 2. <i>Cover Interlock switch on DC Cont not activated (Switch not present on all DC Cont's, see 33449A-04 or 33459A-02).</i> 3. <i>Out of Spec Media.</i> 4. <i>Dry Fuser Cleaning Pad.</i> 5. <i>Replace Fuser Assy.</i> |
| <p>BACK of Page DIRTY? (Oct 94)</p> | <ol style="list-style-type: none"> 1. <i>Inside of Printer Dirty?</i> 2. <i>Lower Fuser Roller contaminated. (i.e Preprinted Letterhead melting in fuser See Paper Spec's.</i> 3. <i>L2 & L3 ONLY - use Test Tool to verify "Corona wire Stuck ON". Replace RG1-0906-000CN cable (HVPS to DC Controller).</i> |
| <p>Light-Brown "OIL-LIKE" 10mm Stain on the Front RHS of a DUPLEXED Page. (Mar 94)</p> | <p>This stain can appear on the front side of a Duplexed Page when the duplex feature is NOT used for several weeks. <i>This problem will typically resolve itself after 10/50 pages. This is due to "Oblique Roller" in Duplex area, this roller has a preservative which can accumulate on the roller if unused.</i> <i>See Service Note 33447A-10 for more detail.</i></p> <ol style="list-style-type: none"> 1. <i>Run through 10/50 pages to clean this roller.</i> 2. <i>Clean roller with paper, not alcohol.</i> 3. <i>Replace Oblique Roller RG1-1356-000CN.</i> |
| <p>STREAKS down the Page? (Gary McGaw - LJ2 - Jan 95)</p> | <p>These streaks were of a lighter background in appearance. Adjusting Density seemed to improve towards being acceptable. <i>The use of Non-HP EP Toner Cart's were the cause of this pbm, use HP EP Cart's if more reliable results are required. Trade billing customer should be considered.</i></p> |

LJII/III/IIID/IIID - PAPER PATH PROBLEMS

| | |
|---|--|
| <p>ERROR 13, after approx. 20-30 pages, paper jamming underneath pick-up rollers. When this fault occurs several lines are partly overprinted.</p> | <p><i>Replace pick-up assy complete, including clutch.</i></p> |
| <p>ERROR 13 Intermittent</p> | <p>Printer had been worked on previously, CE had routed fibre optic cable wrong way, thus allowing it to restrict movement of paper out sensor bail. <i>Take care to Route Fibre Optics cable correctly.</i></p> |
| <p>Intermittent ERROR 13, can be associated with Error 50.</p> | <p><i>Replace RG1-0907-000CN Fusing Assy cable, this is known to be intermittent.</i></p> |
| <p>ERROR 13 & 51 (LJIID) Very Intermittent, motor does not turn and does not feed paper. Error 13 appear first and then 51.</p> | <p>Faulty Lid switches on <i>DCPS Supply assy, replace this module.</i></p> |
| <p>ERROR 13 Intermittently and Main Motor seems to Pulse as paper moves through the printer? (LJIID) (S. Starway - Bill'cay - an 94)</p> | <p><i>Teeth were missing off one of the "Upper Feed Drive Assy" gears. (P/N RG1-0934-000CN) See page 8-34 In LJII/IIID Service Manual.</i></p> |
| <p>ERROR 13 ON POWER-UP. (New Info) (Kim Bateman - Basingstoke)</p> | <p>Upper Cooling fan was found to be pulling down 24v. <i>Replace Upper Cooling Fan.</i></p> |
| <p>ERROR 13 (Paper Jams) and Tearing RHS of Sheet</p> | <p>Caused by small steel tab (Far LHS as viewed from front) on paper cassette tray. If this is bent down, it will cause paper jams. <i>Correct by straightening this metalwork on the Paper Cassette tray.</i></p> |
| <p>False ERROR 13 or Paper Out or Manual Feed problems.</p> | <p>Paper out flag becomes wedged arising to conditions described. <i>Fix was to reinsert LH end of paper flag in its pivot position.</i></p> |
| <p>ERROR 13 when using "FOOLSCAP" media. Leaves approx. 1 inch of paper in the fuser unit.</p> | <p>As this paper is a non-standard size for the paper trays, it can only be realistically fed via manual I/P. <i>Ensure the escape sequence to select "Legal Size" paper is implemented.</i></p> |
| <p>ERROR 13 from Upper Tray Only? (Graham Stead - UK - Feb 95) (LJIID)</p> | <p>Replacing the following parts resolved this pbm, not sure which part actually fixed pbm: <ol style="list-style-type: none"> 1. Upper Main Motor & Drive assy (Fig 8-11 item 1&3) 2. Upper Feed Drive assy (Fig 8-12 item 1) </p> |

LJII/III/IID/IIID - PAPER PATH PROBLEMS

| | |
|---|---|
| <p>IMAGE Moving up or down the PAGE, perhaps up to 12mm? <i>(Guy Picton - Nov 94)</i></p> | <p><i>1. Registration Solenoid sticking, replace.</i> <i>2. Replace Paper Control PCA & maybe DCCont</i> Note: First page may be affected only.</p> |
| <p>LINE SPACING between LJII & LJII DIFFER?</p> | <p>The LJII has a different paper path when compared to the LJII. <i>HP specify that line difference can vary by +/- 2.5mm per page.</i></p> |
| <p>Faulty Registration <i>(Oct 94)</i></p> | <p><i>1. Worn Feed Roller Assy</i> <i>2. Replace Registration Assy</i> <i>3. Check or Replace faulty Cassette Tray.</i> <i>4. Out of Spec media?</i></p> |
| <p>IMAGE SKEWED? <i>(Oct 94)</i></p> | <p><i>1. Ensure paper & Paper Tray are installed correctly.</i> <i>2. Replace worn Feed Roller Assy.</i> <i>3. Replace Registration Assy.</i> <i>4. Is the Fuser Insulator Pad Missing?</i></p> |
| <p>SKEW PROBLEMS? (Top and bottom) (margins only)</p> | <p><i>1. Have you replaced the Scanner Unit previously?</i> If so check Service Note 33440A-2. <i>2. If all else fails re-shim Scanner Unit. (This should be factory-set, but in one case we found the setting incorrect)</i></p> |
| <p>SKEWED by 5mm at the top of the page. (LJIII)</p> | <p>"L" shaped bracket on LHS of the Paper Cassette Tray which is held in position by plastic peg had lost its circlip. The "L" shaped bracket had worked loose, <i>reseated and returned circlip to resolve problem.</i></p> |
| <p>DELAMINATION of the rear side of page near the leading top edge. There can be two marks which are in line with the two eccentric cam rollers mounted on the I/P Pick-up Assy. The problem can be intermittent. <i>(Updated Info)</i> <i>(LJII / III / IID / IIID)</i></p> | <p>This problem can occur on LJII/III/IIID & IIID's. <i>1. Changing media to a Laser Quality paper that adheres to the Paper Spec's Guide always resolves this problem.</i> <i>2. Replace both the Separation Pad & I/P feed Assy.</i> <i>3. If customer is NOT using extremely light or heavy paper (16lb or 36lb), remove one of 2 tension spr'gs (P/N RA1-3871-000CN) on Reg Assy. Remove the spring on the side that delamination occurs. DO NOT remove both springs. (Supported by Div)</i> <i>4. If 1 & 2 do not work for you, try this unsupported method. Remove high spot off the 2 eccentric cams these cams are part of the I/P feed Assy.</i> NOTE: If the paper is of extremely poor quality items 2, 3 & 4 may not help at all.....</p> |
| <p>No MANUAL FEED</p> | <p><i>Replace Paper Control PCA.</i></p> |

LJII/III/IIID/IIID - PAPER PATH PROBLEMS

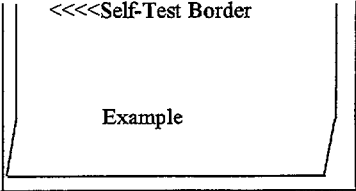
| | |
|--|--|
| <p>PAPER JAMS IN DUPLEX MODE (INTERMITTENT) Paper -jams just prior to reaching the Fusing Assy. Duplexing image may shift up the page. <i>(LJIIID)</i></p> | <p><i>See Service Note 33447AU-03 concerning the premature failure of Duplex Drive Roller Clutches.</i></p> |
| <p>PAPER JAMS as paper begins to exit fuser into SWBACK area. <i>(LJIIID/LIIID)</i> <i>(Ian Longstaff-B'ham)</i></p> | <p>It was noted that the switchback was slightly twisted on RHS (as viewed from front of printer), this was preventing the operation of SL7(Switchback Deflection Solenoid) in the switchback. BLACK bracket on RHS of switchback was correctly positioned to resolve problem.</p> |
| <p>Does not Feed from Lower Tray & does not FUSE correctly? <i>(LJIIID / LJIIID)</i></p> | <p><i>Replacing the DC Controller resolved the feed problem</i> Note: The problem with not fusing was due to the fuser switch on DC Controller NOT installed correctly after its replacement.</p> |
| <p>High rate of PAPER JAMS in DUPLEX mode. PJ occurs as leading edge exits the Vertical Reg Guide and catches on Mylar strip on lower guide in the duplex drive Roller Assy. PJs increase dramatically using LEGAL size paper. <i>(LJIIID)</i></p> | <p><i>See Service Note 33447A-07; Replace Duplex Drive Roller Assy, lower guide with RG1-1345-060CN.</i></p> |
| <p>PAPER JAMS in Duplex Mode only? <i>(LJIIID)</i></p> | <p>In Duplex mode the paper enters & exits the Switch-Back OK. When approx half the sheet is still in the switchback and half in the duplex, the paper appears to slow down and stops with a Paper Jam 2 inches from the Duplex Drive rollers. Replacing the Upper Duplex Drive assy (P/N RG1-1344-000CN) resolved this problem. There was insufficient nip between this roller and the Lower roller.</p> |
| <p>Paper appears SKEWED at the bottom of page only (Portrait). There is a slight "kink" in the vertical border that begins approx 38mm from bottom of page. Duplex Only. (LJIIID / LJIIID) See Example opposite. <i>(Lucy Miles - Winn)</i></p> | <p>1. Replace Duplex Clutch (SL2) and its associated drive rollers.</p> <div style="text-align: center;">  </div> |

LJII/III/IIID/IIID - PAPER PATH PROBLEMS

| | |
|---|---|
| <p>Paper "DOG EAR's" using A5 size paper, fed from manual tray? <i>(M. Brabyn - LJ3 - Jan 95)</i></p> | <p>The leading edge corners are bent back to give the so called "Dog Ear" effect. <i>This is caused by the deflector in the Fuser Exit area. A5 paper just happens to coincide with 2 of these deflector pawls. As A5 paper is not supported the unofficial actions to try are:</i></p> <ol style="list-style-type: none"><i>1. Try 100gm paper straight through.</i><i>2. Displace manual feed guide on cassette tray cover, remove one screw & allow guides to move, then replace this screw. The disadvantage of this is the the printed image would have to be offset to compensate.</i> |
| | |

LJII/III/IIID/IIID - PostScript Problems

| | |
|---|--|
| <p>ERROR 55? Only when Post-Script Cart's (33439P/Q) are installed. (LJIII only)</p> | <p>When some HP PostScript cartridges (33439P/Q) are installed in a LJIII, the printer completes Self-Test and then locks-up in the start-up page. The main motor starts, but paper is never picked from the paper tray. Error 55 may be displayed if the printer is powered on for more than 3 minutes. This situation only occurs with LJIII's that have the newer DC Controllers (P/N RG1-2706-000CN). The exchange PCA (33449-69004) is NOT affected by this problem. <i>The PS Cart's must be exchanged with another with a DC of 3150 and may a blue dot on its shell. See service Note 33439P-01 or 33439Q-01 for further detail.</i></p> |
|---|--|

LJII/III/IIID/IIID - MANUAL FEED PROBLEMS

| | |
|---|--|
| <p>No MANUAL FEED</p> | <p><i>Replace Paper Control PCA.</i></p> |
| <p>ERROR 13 when using "FOOLSCAP" media. Leaves approx. 1 inch of paper in the fuser unit.</p> | <p>As this paper is a non-standard size for the paper trays, it can only be realistically fed via manual I/P. <i>Ensure the escape sequence to select "Legal Size" paper is implemented.</i></p> |

LJIIID / LJIIID - POWERED ENVELOPE FEEDER

| | |
|--|---|
| <p>On Power Up, normal 05 then PAPER JAM (ERROR 13) when Envelope Feeder is Connected?</p> | <p><i>Replace Paper Control PCA</i></p> |
| <p>After long periods of alternate printing from Envelope Tray, Upper Tray, then Lower Tray DARK Background SMUDGES appears in the Upper middle part of page. Replacing with NEW EP Cartridge appears to fix problem for a short period of time and then returns.</p> | <p>The combination of envelopes and paper used in the Upper Tray caused this problem. <i>Selection of improved quality envelopes and paper reduced problem dramatically.</i></p> <p>Note: By leaving the faulty EP Cart's in box or dark cupboard, they will recover and will be usable again.</p> |



HEWLETT
PACKARD

LaserJet / LJ2000
Troubleshooting Guide

Classic Printers

LaserJetIIP / LaserJetIIIP

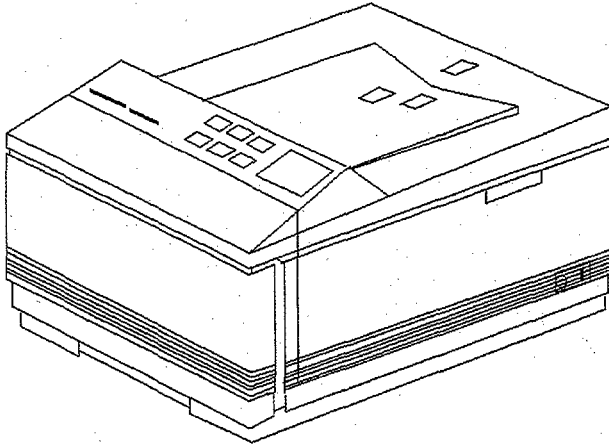

33471 / 33481

Booklet Organisation - Please Read

This chapter has been divided into 5 sections, some parts may appear twice in these sections, this is to enable easier location. The sections are as follows:

- 1) **Faults with Error Numbers** [*Error 13's {Paper jams} in the Paper Path Section*]
- 2) **Miscellaneous Problems**
- 3) **Print Quality Problems**
- 4) **Paper Path Problems** [*All Error 13's {Paper Jams} in this section*]
- 5) **PostScript Problems**

Service Notes up to Oct 93

| | |
|------------|--|
| 33471A-01B | Triac in Power Supply Assy (115v Only). |
| 33471A-02B | Static Induced Error 41 (3 Diode Upgrade Kit). |
| 33471A-03 | IC301 on Scanner Motor Assy may overheat and cause ERROR 52. |
| 33471A-04 | LJIIIP / IIP+ / IIIIP Printer New Fusing Assy Component Incompatibility. |
| C2007A-01 | LJIIIP Plus Update for LJIIIP & LJIIIP Service Personnel. |
| C2007A-02 | LJIIIP / IIP+ / IIIIP Printer New Fusing Assy Component Incompatibility. |
| 33481A-01A | LJIIIP Update for LJIIIP Service Personnel. |
| 33481A-02 | Cannot find reference to this Service Note? |
| 33481A-03 | IC301 on Scanner Motor Assy may overheat and cause ERROR 52. |
| 33481A-04 | LJIIIP / IIP+ / IIIIP Printer New Fusing Assy Component Incompatibility. |

LJ11P / LJ111P - FAULTS WITH ERROR NUMBERS

Please note that all Paper Jams or Error 13's problems, refer to Paper Path part of this section of this manual.

| | |
|--|---|
| <p>"02 WARM UP" CONTINUOUSLY</p> | <p><i>Fault traced to a bad wire connection on J209 of DC Controller PCA (namely pin 1). This is the +24V to MP PICK-UP SOLENOID.</i></p> |
| <p>ERROR 12 (very intermittent)</p> | <p><i>Replace Density PCA. (problem temporary cleared by tapping on this PCA)</i></p> |
| <p>ERROR 12 from Power-up. (Updated)</p> | <p><i>1. Replace Density PCA 2. Replace Fan 3. Replace Scanner Motor (this motor pulled down +12v line) 4. Check PS4 & PS5 Sensors. 5. No Toner Cartridge Installed. 6. External Fuser Access Door not closed.</i></p> |
| <p>When continuous Self-Test "04" is used on PCL5 printers (LJIII/IIID/IIIP), ERROR 20 may occur. (LJIIIP)</p> | <p><i>This is normal for PCL5 printer, NOT PCL4. Due to HPGL2 vector commands used on Self-Test and the additional memory it requires. The number of pages of Self-test which are printed before this error may occur depends on the available RAM. If printer is powered down, more RAM may be available, therefore ERROR 20 may take longer to appear. Note: This is NOT an Error, no further action is required.</i></p> |
| <p>Intermittent ERROR 41 (June 92) (LJIIIP)</p> | <p><i>Install "3 Diode" Fuser Assy, this modified assy prevents static discharge from fuser roller. See Service Note 33471A-02B. Install diode kit as per service note(cheaper) rather than replacing fuser assy. A new fusing assy is now available and is compatible with the LJIIIP, LJIIIP+ & LJIIIP, with the exception of the ORIGINAL fusing assy used in the LJIIIP. See Service Note 33471A-02B for detail</i></p> |
| <p>ERROR 41</p> | <p><i>This can be caused by the Paper Feed system. Have seen this occur mostly from LC Tray. This occurs when paper gets out of synch with the image system. 1. Does it fail from MP Tray? 2. Check paper is feeding correctly from LC Tray.</i></p> |
| <p>ERROR 50 or Printed O/P is not Fusing correctly. (Oct 90)</p> | <p><i>1. Replacing Fusing Assy 2. Replace DC Controller PCA.</i></p> <p><i>Note: Always keep printer powered off for at 10 minutes to allow Fuser Error to reset or Short C212 on DC Controller PCA to ground, printer must be turned off.</i></p> |

LJ11P / LJ111P - FAULTS WITH ERROR NUMBERS (Con't)

| | |
|--|---|
| <p>ERROR 51 Intermittent (LJ11P). Normal troubleshooting procedure does not resolve this problem. <i>(Mar 94)</i></p> | <p>If the normal troubleshooting paths fails and the normal assys/components have been replaced, please <i>contact RCE for further action plan, cold environments are known to cause this problem on some LJ11P's.</i></p> |
| <p>ERROR 51? <i>(LJ11P/LJ111P - Jan 95)</i></p> | <p><i>This can be caused by Non-HP Cart's (Refilled). If non HP Cart is used try HP EP Cart to at least eliminate this possibility. If this is the cause in normal circumstances the customer should be billed.</i></p> |
| <p>ERROR 52 <i>(New Info)</i></p> | <p>Condensation accumulating on Scanner Mirror. See <i>Service Note 33471A-03 or 33481A-02. Replace scanner motor assy, note it has the same P/N as the old assy, and/or improve environment where printer is located.</i> <i>P/N RG1-1771-000CN Scanner Motor Assy</i></p> |
| <p>ERROR 53</p> | <p><i>1. Error 53 Unit 1 - Replace top memory card. 2. Error 53 Unit 3 - Replace bottom memory card.</i></p> |
| <p>ERROR 57</p> | <p><i>1. Error 57 Unit 1 - Incompatible memory card (top) 2. Error 57 Unit 2 - Incompatible memory card (bot)</i></p> |
| <p>ERROR 79 <i>(Trevor Smith - B'ham)</i></p> | <p>This LJ11P had 512Kb of memory, the customer was using WINDOWS. The memory within windows NOTE: In general, for Error 79, this can be caused by Software/Drivers, Memory PCA's, Font-Macro-Personality Cartridges, Optional I/O cards or Formatter PCA.</p> |
| | |

LJ11P / LJ111P - MISCELLANEOUS

"MOANING" NOISE" in the vicinity of the Paper Pick-up assy

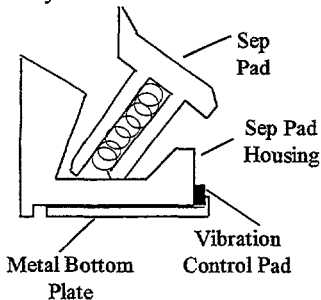

1. New Separation Pad available (P/N RG1-1912-080CN).
2. Try different paper, Xerox 80 paper (Black reams) is known to work well in these printers. Please note HP does not recommend paper, it's the customer's responsibility to test for a suitable paper.
3. Smoother papers can cause problem.

Note: This problem may still be apparent in a small % of printers, therefore try the following unsupported actions.

- a) Add small piece of rubber in front of Separation Pad housing to damp oscillation of this assy.
- b) Try cutting off 1 or 2 turns of the Separation Pad Spring. (NOT Supported, but may work)

Printer "NOISY", not Separation Pad "Moan".

(Geoff Banks - Preston)

See Main Gear drive assy Fig 8-5 in service manual, gears in this area should have a coating of "Silicon grease". In this case, there was none. If gears are replaced, apply thin coat of this grease.
See Page 8-12 Fig 8-5 items 10 & 24

Not FUSING correctly and print SMEARED down LHS of page. Typically a band of approx. 25mm down LHS of page.

"U" Shaped bracket on Pressure Fuser Roller on LHS of printer (as viewed from the front) fails and breaks. This allows less fuser "nip" on Fuser Rollers on LHS.

Print "CRACKING" when paper is folded. White lines may be seen running through characters where page is folded.

(Updated)

Toner comprises of pigmented plastic material and iron oxide. When subjected to high temperatures these individual plastic particles become part of a larger plastic image on the page. When the page is folded the plastic must give in some way. If the print image is well set into the paper, the resulting break in the plastic will NOT be very apparent. However, if the toner has NOT been able to penetrate the paper fibres, the "Crack" in the plastic image will be amplified. A white line will be seen through image. To Minimise:

1. Ensure paper meets ALL Paper Specs, see guide 5002-1801. In particular pay attention to the smoothness (100-250 Sheffield) and/or "Wax Pick" (>11 Dennison)
2. A lighter Density setting will ensure less toner used, thus minimising problem.
3. A lighter character stroke may also help.

Note: See HP LaserJet Reference Guide, section 4, "Cracking Up" page 4-11 (revision RCO 4.01)

LJ11P / LJ111P - MISCELLANEOUS (Con't)

| | |
|---|--|
| <p>PS BUSY when using HP Postscript Cartridge (HP 33439P). A continuous "PS BUSY" condition can occur if "AUTO-CONTINUE" is ON and the document is longer than 1 to 2 pages. If the page is printed it may result in missing lines, shifted text, malformed letters. Faulty page will be ejected and Error will be displayed.</p> | <p>This a similar problem to the Intermittent Error 41, caused by static discharge from fuser assy. PS can not report Error 41, instead it displays PS BUSY. <i>Install diode in fuser assy (Cheaper) or replace fuser assy(Expensive).</i> See service note 33471A-02B</p> |
| <p>33481A LJIIP with Postscript installed, recognises printer as a LJIIP (512Kb)? <i>(Updated)</i></p> | <p>A 33439P most probably will be installed, <i>a LJIIP requires the Postscript cartridge 33439Q. A LJIIP can also use the C2089A Switchable PS Cartridge.</i> See Postscript compatibility matrix in section 1 of this book.</p> |
| <p>LJIIP IMAGE MOVES DOWN page by Approx. 3 inches. This problem can occur when <i>Pacific Page Postscript plug-in cartridges</i> are used with this printer. Printer OK in PCL mode. <i>(New Info)</i></p> | <p>The problem has been identified down to the NVRAM page count of the LJIIP caused by the Pacific Page PS Cartridge. This page counter does not increment using this PS cartridge. It seems when the counter reaches 2047, for some reason the PS Cart believes it has a Legal paper size installed. This is why print image moves down the page. CE's have in the past replaced both Formatter and DC Controller PCA's, this will fix in the short term, but will fail again when the page counter reaches 2047. <i>This is NOT a HP problem, the customer MUST contact Pacific Page.</i> A temporary workaround is: 1. Reset page counter to zero via Service Mode, remove Pacific Page PS cartridge to do this. 2. Use HP PS cart 33439Q or C2089A(LJIIP only) This problem should be resolved by now, but may show up occasionally.</p> |
| <p>REGISTRATION CHECK See Page section 4 in Service Manual for Registration Adj. <i>(Oct 94)</i></p> | <p>Print off A Self-test Page: TOP - Leading Edge to First Dot Row (A4/Ltr) = 3mm +/- 1mm. (Top Horz Border) LEFT - Left Edge to First Dot Row (Left Vert Border) = 5mm +/- 2mm. (A4) LEFT - Left Edge to First Dot Row (Left Vert Border) = 6mm +/- 2mm. (Ltr)</p> |

LJ11P / LJ111P - MISCELLANEOUS (Con't)

| | |
|--|---|
| <p>IMAGE SKEW (Oct 94)</p> | <p>Max Image tolerance = 1.5mm over 259mm(10.2") Check: 1. Is paper correctly installed in MP or LC Tray? 2. Check Media for paper quality problems, refer customer to Paper Spec's Guide 5002-1801. 3. Is media cut square? 4. Worn MP or LC Pick-up roller. 5. Replace Separation Pad. 6. Replace I/P Roller.</p> |
| <p>Customer printing BOTH SIDES of the Page or DUPLEX printing? This may cause paper jams, paper feeding or print quality problems. (LJ11P/L11P - Feb 95)</p> | <p>This model of LaserJet is a SIMPLEX printer and is not designed for Duplex printing. Although this printer can print on both sides, <i>this practice is not supported by HP</i>. For the general HP statement on "Duplex printing v Simplex" please reference HP Reference Guide (Green Book) section 3.</p> |
| <p>Customer REFEEDING paper, not two sided printing? (LJ11P/L11P - Feb 95)</p> | <p>As above refer to HP general statement on "Duplex printing v Simplex" in HP Reference Guide (Green Book) section 3.</p> |
| <p>PAPER JAMS/MISFEEDS/SKEWING caused by customers practice of INTERLEAVING different types of paper in paper trays? (LJ11P/L11P - Feb 95)</p> | <p><i>Interleaving, where a variety of paper is placed in the paper tray, is not recommended by HP</i>. This practice is likely to lead to Paper jams & Misfeeds. For the general HP statement on "Interleaving Paper" please reference HP Reference Guide (Green Book) section 3.</p> |
| | |

LJ11P / LJ111P - PRINT QUALITY PROBLEMS

| | |
|--|---|
| <p>Repetitive MARKS appearing on page at regular intervals, see table opposite.</p> | <ol style="list-style-type: none"> 1. 94mm (3.7inches) apart (EP Drum Defect). 2. 63mm (2.48inches) apart (Upper Fuser Roller) 3. 54mm (2.13inches) apart (Lower Fuser Roller) 4. 52mm (2.05inches) apart (Transfer Roller) 6. 51mm (2.01inches) apart (Developing Roller) 7. 49mm (1.93inches) apart (I/P Feed Rollers) 8. 38mm (1.5inches) apart (Charging Roller) |
| <p>THIN VERTICAL BLACK LINES? <i>(Oct 94)</i></p> | <ol style="list-style-type: none"> 1. Toner Drum scratched, replaced. 2. Scratches/Scores on Fusing Rollers. |
| <p>Horizontal BLACK LINES?</p> | <ol style="list-style-type: none"> 1. Check Fibre Optics cable, may be associated with Error 41 or 51. 2. Replaced DC Controller. |
| <p>BLACK BANDS appear across page, approx. 3.7 inches apart, around 0.5 inches wide. May appear whilst printing the first few pages after standing idle for a while. <i>(Updated)</i></p> | <ol style="list-style-type: none"> 1. Replace EP Cartridge. 2. Check for direct sunlight, does it occur at one particular time of day? |
| <p>WHITE BANDS down the page. <i>(Heilier Waite - Glasgow)</i> <i>(New Info)</i></p> | <p>The laser shutter had become adrift and was blocking the laser beam. <i>Replace lower cover assy P/N RGI-1773-000CN.</i></p> |
| <p>BLANK PAGE? Occurs with both Self-Test and customers print files. <i>(New Info)</i> <i>(Ian Longstaff - B'ham)</i> <i>(LJ11P)</i></p> | <p>No image on EP Drum and Print Engine test was found to be working. <i>Replacing the Formatter PCA resolved this problem.</i></p> |
| <p>BLANK PAGE? <i>(Oct 94)</i></p> | <ol style="list-style-type: none"> 1. Seal tape left in Toner Cartridge. 2. Empty Toner Cartridge 3. Replace Toner Cartridge Interlock Tab. 4. Replace Transfer Roller. 5. Replace HVPS. 6. Replace DC Controller. |
| <p>BLACK PAGES? <i>(Oct 94)</i></p> | <ol style="list-style-type: none"> 1. Replace with HP Toner Cartridges 2. Replace HV Contact Assy. 3. Replace Fibre Optics cable. 4. Replace HVPS. 5. Replace DC Controller PCA. |

LJ11P / LJ111P - PRINT QUALITY PROBLEMS (Con't)

| | |
|---|--|
| <p>BLACK Pages with some Thin Horizontal WHITE LINES? This will also give ERROR 51 (Oct 94)</p> | <p>Damaged or severed Fibre Optics cable. <i>Replace the Fibre Optics cable.</i></p> |
| <p>FAINT PRINT? (Oct 94)</p> | <ol style="list-style-type: none"> 1. <i>Density Slide set to LHS, move to middle position.</i> 2. <i>EP Cartridge empty?</i> 3. <i>Replace Transfer Roller.</i> 4. <i>Replace HVPS.</i> 5. <i>Replace DC Controller PCA.</i> 6. <i>Media out of spec, refer to 5002-1801 Paper Spec's Guide.,</i> |
| <p>BACKGROUND? (Oct 94)</p> | <ol style="list-style-type: none"> 1. <i>Replace EP Cartridge, HP Toner Cart's used?</i> 2. <i>Media out of spec, refer to 5002-1801 Paper Spec's Guide.</i> 3. <i>Clean or replace Transfer Roller.</i> 4. <i>Print Density may need adjusting.</i> 5. <i>Inside of printer dirty, clean.</i> |
| <p>COMPRESSED PRINT , maybe compressed on any part of the page. It may look like text compressed into a "thin line" or gaps between lines.</p> | <p>Sometimes EP Toner Cartridge "freezes" which makes the gear extremely hard to turn. The shaft on the Drum drive gear continues to turn for a short time even though the rest of the printer is functioning. The result is that the drum shaft turns and the drum drive gear does not. The softer plastic of the drum drive gear gives, even though it is "keyed". <i>Repape drum drive gear P/N RG1-1777-000CN</i></p> |
| <p>IMAGE SKEW? (Oct 94)</p> | <ol style="list-style-type: none"> 1. <i>Is paper loaded correctly?</i> 2. <i>Media out of spec, refer to 5002-1801 Paper Spec's Guide.</i> 3. <i>Worn LC or MP Pick-up roller.</i> 4. <i>Replace Separation Pad.</i> 5. <i>Replace I/P Roller.</i> |
| <p>REGISTRATION Problems? (Oct 94)</p> | <ol style="list-style-type: none"> 1. <i>Check MP or LC Paper Trays are not overloaded.</i> 2. <i>Paper Guides on MP Tray or Envelope Tray adjusted too tight.</i> 3. <i>Media out of spec, refer to 5002-1801 Paper Spec's Guide.</i> 4. <i>If 1st dot row is NOT 3mm +/-1mm from leading edge of page, then adjust VR201 Reg pot on DC Controller PCA.</i> 5. <i>Check for worn or damaged Drive Gears.</i> 6. <i>Replace I/P Paper Sensor PS1.</i> <p>NOTE: <i>For Registration Check see Miscellaneous section or Service Manual section 4.</i></p> |

LJ11P / LJ111P - PRINT QUALITY PROBLEMS (Con't)

| | |
|--|---|
| <p>WRINKLED PAPER and/or PRINT SMUDGED on lower part of printed page.</p> | <p><i>Replace fuser assembly.</i></p> |
| <p>NOT FUSING correctly and PRINT SMEARED down RHS of page. Typically a band of approx. 25mm down RHS of page</p> | <p>"U" Shaped bracket on Pressure Fuser Roller on LHS of printer (as viewed from the front) fails and breaks. This allows less fuser "nip" on Fuser Rollers on LHS. See next item below for more detail. <i>Replace Fuser Assy or "U" shaped bracket, Part Number RAI-7587-000CN</i></p> |
| <p>Character VOIDS / Poor FUSING (Oct 94) <i>See "Character Void" statement in HP LaserJet Reference Guide (Green Book) for more detail.</i></p> | <ol style="list-style-type: none"> 1. <i>Bad Transparencies, bond, laid or linen paper.</i> 2. <i>Paper is out of spec, refer to 5002-1801 Paper Spec's Guide.</i> 3. <i>Replace Transfer Roller.</i> 4. <i>Replace Fusing Assy.</i> |
| <p>33471A Paper CREASING may occur on LJ11P as well.</p> | <p>Bush in Fuser Assy breaks (Item 7 Fig 8-8), this causes less friction between pressure and fuser rollers on that side of fuser, causing creasing. It may also cause smudging on the RHS of the page. <i>Replace Fuser Assy or "U" shaped bracket, P/N RAI-7587-000CN</i></p> |
| <p>MISSING PRINT? Approx 13/14mm of print was missing off the trailing edge of the page when veiwed in portrait mode. <i>(Steve Obia - Billericay)</i> <i>(New Info) (LJ11P)</i></p> | <p><i>Replacing the Feeder Assy, which includes PS1 sensor resolved this problem.</i> As this sensor was at fault it is not clearly understood why no Paper Jams occurred?? This feeder Assy is located by the Separation Pad housing.</p> |
| <p>LJ11P IMAGE MOVES DOWN page by Approx. 3 inches. This problem can occur when <i>Pacific Page Postscript plug-in cartridges</i> are used with this printer. Printer OK in PCL mode. <i>(New Info)</i></p> | <p>The problem has been identified down to the NVRAM page count of the LJ11P caused by the Pacific Page PS Cartridge. This page counter does not increment using this PS cartridge. It seems when the counter reaches 2047, for some reason the PS Cart believes it has a Legal paper size installed. This is why print image moves down the page. CE's have in the past replaced both Formatter and DC Controller PCA's, this will fix in the short term, but will fail again when the page counter reaches 2047. <i>This is NOT a HP problem, the customer MUST contact Pacific Page.</i> A temporary workaround is: <ol style="list-style-type: none"> 1. <i>Reset page counter to zero via Service Mode, remove Pacific Page PS cartridge to do this.</i> 2. <i>Use HP PS cart 33439Q or C2089A(LJ11P only)</i> This problem should be resolved by now, but may show up occasionally.</p> |

LJ11P / LJ111P - PRINT QUALITY PROBLEMS (Con't)

| | |
|--|--|
| <p>Text looks BOLDER in a band down RHS of page. This band is approx. 25mm wide and in its worst case may appear also with a band of Background. A band may also appear down LHS of page.</p> <p><i>(Updated)</i></p> | <p>Normally strong sunlight causes this problem. Position printer well away from this window, etc.</p> <div data-bbox="582 227 879 619" style="border: 1px solid black; padding: 10px; margin: 10px auto; width: fit-content;"> <pre> OOOOOOOOOOOOOOOOOOOOOOOO DDDDDDDDDDDDDDDDDDDDDDDD QQQQQQQQQQQQQQQQQQQQQQQQ HHHHHHHHHHHHHHHHHHHHHHHH DDDDDDDDDDDDDDDDDDDDDDDD CCCCCCCCCCCCCCCCCCCCCCCC UUUUUUUUUUUUUUUUUUUUUUUU </pre> <p style="text-align: center;"> } e.g. } Darker } band } down } page </p> </div> |
| <p>TOPS & BOTTOMS of characters clipped. This occurs every 19mm down the page.</p> <p><i>(Ron Wallace - Manchester)</i> <i>(New Info)</i></p> | <p>This problem initially looks like a repetitive roller problem. <i>Replacing the Formatter PCA resolved this problem.</i></p> |
| <p>Print "CRACKING" when paper is folded. White lines may be seen running through characters where page is folded.</p> <p><i>(Updated)</i></p> | <p>Toner comprises of pigmented plastic material and iron oxide. When subjected to high temperatures these individual plastic particles become part of a larger plastic image on the page. When the page is folded the plastic must give in some way. If the print image is well set into the paper, the resulting break in the plastic will NOT be very apparent. However, if the toner has NOT been able to penetrate the paper fibres, the "Crack" in the plastic image will be amplified. A white line will be seen through image.</p> <p>To Minimise:</p> <ol style="list-style-type: none"> 1. <i>Ensure paper meets ALL Paper Specs, see guide 5002-1801. In particular pay attention to the smoothness (100-250 Sheffield) and/or "Wax Pick" (>11 Dennison)</i> 2. <i>A lighter Density setting will ensure less toner used, thus minimising problem.</i> 3. <i>A lighter character stroke may also help.</i> <p>Note: See HP LaserJet Reference Guide, section 4, "Cracking Up" page 4-11(revision RCO 4.01)</p> |

LJ11P / LJ111P - PRINT QUALITY PROBLEMS (Con't)

| | |
|--|--|
| <p>THIN LINE Down page, approx 50mm from RH edge of page? (LJ11P) <i>(Les O'Reilly - Dublin - Feb 95)</i></p> | <p><i>This pbm was resolved by replacing the Formatter PCA. At first sight this pbm does not look like a Formatter fault. To help you diagnose this remove Formatter PCA completely and use Engine Test to ascertain if pbm is still apparent. Even though there is no display the "tramlines" should print.</i></p> |
| | |

LJ11P / LJ111P - PATH PATH PROBLEMS

| | |
|---|--|
| <p>ERROR 13 (permanent at power on)</p> | <p>PS1 sensor located by Separation Pad was installed incorrectly by CE. The sensor flag had been installed the wrong side of the roller in this area, therefore permanently activated. <i>Reposition PS1 flag.</i></p> |
| <p>ERROR 13 Feeds paper in approx. .2.5", leading edge stops level with Primary Corona Roller then Error 13.</p> | <p>Gear in centre of "input feed roller" had come adrift of the shaft, so providing no drive to rubber rollers mounted on it.(RG1-1778-000CN) <i>Reinstall this gear in its correct position.</i></p> |
| <p>Permanent ERROR 13 after '05' is displayed.</p> | <p>PS1 Sensor arm had been installed on the incorrect side of I/P Feed Rollers, leaving flag to permanently activate sensor. (BEWARE). <i>Install PS1 flag in its correct position, check flag spring.</i></p> |
| <p>Solid ERROR 13 when feeding from either the MP Tray or the Optional Paper Cassette. <i>(New Info)</i></p> | <p>Paper is just about to enter the Fuser Assy when this paper jam occurs. This occurs every time. <i>Replacing 1. PS1 input sensor resolved this problem, or 2. Small spring on PS1 flag has come off.</i></p> |
| <p>ERROR 13 as trailing edge of paper is in the EP Drum area. <i>(Steve Clarke - UK)</i> <i>(New Info) (LJIIP)</i></p> | <p><i>Replacing assy that contains PS1 sensor resolved this problem.</i> This sensor PS1 is located by the SeparationPad housing.</p> |
| <p>ERROR 13 Paper Jam when feeding from MP Tray. (Note: printer may be new)</p> | <p>Ref. SERVICE MANUAL Fig.8.2 (paper path door item 4 (arm,paper guides). One end of this guide is pivoted, but had slipped off bar causing jams. Simply gain access to this guide by removing pick-up roller and transfer roller. <i>Remove screw which holds item 4 to item 7. Re-pivot item 4.</i></p> |
| <p>33471A Paper CREASING may occur on LJ11P.</p> | <p>Bush in Fuser Assy breaks (Item 7 Fig 8-8), this causes less friction between pressure and fuser rollers on that side of fuser, causing creasing. It may also cause smudging on the LHS of the page. <i>Replace the Fuser Assy or "U" shaped bracket (P/N RAI-7578-000CN).</i></p> |
| <p>SKEWING at the top of the page, rest of page looks OK.</p> | <p>Front Door hinge loose on LHS, therefore less friction on this side compared to RHS, thus skewing at top of page approx. 2mm. <i>Correct problem or replace front door assy.</i></p> |

LJ11P / LJ111P - PATH PATH PROBLEMS (Con't)

| | |
|--|--|
| <p>REGISTRATION CHECK</p> <p>See Page section 4 in Service Manual for Registration Adj.</p> <p>(Oct 94)</p> | <p>Print off A Self-test Page:</p> <p>TOP - Leading Edge to First Dot Row (<i>A4/Ltr</i>) = 3mm +/- 1mm. (Top Horz Border)</p> <p>LEFT - Left Edge to First Dot Row (<i>Left Vert Border</i>) = 5mm +/- 2mm. (<i>A4</i>)</p> <p>LEFT - Left Edge to First Dot Row (<i>Left Vert Border</i>) = 6mm +/- 2mm. (<i>Ltr</i>)</p> |
| <p>IMAGE SKEW</p> <p>(Oct 94)</p> | <p><i>Max Image tolerance = 1.5mm over 259mm(10.2")</i></p> <p><i>Check:</i></p> <ol style="list-style-type: none"> <i>1. Is paper correctly installed in MP Tray?</i> <i>2. Check Media for paper quality problems, refer customer to Paper Spec's Guide 5002-1801.</i> <i>3. Is media cut square?</i> |
| <p>Customer printing BOTH SIDES of the Page or DUPLEX printing? This may cause paper jams, paper feeding or print quality problems.</p> <p>(<i>LJHP/LHP - Feb 95</i>)</p> | <p>This model of LaserJet is a SIMPLEX printer and is not designed for Duplex printing. Although this printer can print on both sides, <i>this practice is not supported by HP</i>. For the general HP statement on "<i>Duplex printing v Simplex</i>" please reference HP Reference Guide (Green Book) section 3.</p> |
| <p>Customer REFEEDING paper, not two sided printing?</p> <p>(<i>LJHP/LHP - Feb 95</i>)</p> | <p>As above refer to HP general statement on "<i>Duplex printing v Simplex</i>" in HP Reference Guide (Green Book) section 3.</p> |
| <p>PAPER JAMS/MISFEEDS/SKEWING caused by customers practice of INTERLEAVING different types of paper in paper trays?</p> <p>(<i>LJHP/LHP - Feb 95</i>)</p> | <p><i>Interleaving, where a variety of paper is placed in the paper tray, is not recommended by HP</i>. This practice is likely to lead to Paper jams & Misfeeds. For the general HP statement on "<i>Interleaving Paper</i>" please reference HP Reference Guide (Green Book) section 3.</p> |

LJ11P/LJ111P - OPTIONAL PAPER TRAY PROBLEMS

| | |
|--|---|
| <p>UNABLE TO RECOGNISE Lower Optional Tray?</p> | <p>Check connector J901 on lower tray PCA. <i>Carefully resolder if necessary or replace this PCA.</i></p> |
| <p>Solid ERROR 13 when feeding from either the MP Tray or the Optional Paper Cassette.</p> <p>(<i>New Info</i>)</p> | <p>Paper is just about to enter the Fuser Assy when this paper jam occurs. This occurs every time. <i>Replacing PSI input sensor resolved this problem.</i></p> |

LJ11P / LJ111P - POSTSCRIPT PROBLEMS

| | |
|---|---|
| <p>PS BUSY when using HP Postscript Cartridge (HP 33439P). A continuous "PS BUSY" condition can occur if "AUTO-CONTINUE" is ON and the document is longer than 1 to 2 pages. If the page is printed it may result in missing lines, shifted text, malformed letters. Faulty page will be ejected and Error will be displayed.</p> | <p>This is a similar problem to the Intermittent Error 41, caused by static discharge from fuser assy. PS can not report Error 41, instead it displays PS BUSY. <i>Install diode in fuser assy (Cheaper) or replace fuser assy (Expensive).</i> See service note 33471A-02B</p> |
| <p style="text-align: center;">33481A</p> <p>LJ11P with Postscript installed, recognises printer as a LJ11P (512Kb)?</p> <p style="text-align: center;"><i>(Updated)</i></p> | <p>A 33439P most probably will be installed, <i>a LJ11P requires the Postscript cartridge 33439Q. A LJ11P can also use the C2089A Switchable PS Cartridge.</i> See Postscript compatibility matrix in section 1 of this book.</p> |
| <p>LJ11P IMAGE MOVES DOWN page by Approx. 3 inches. This problem can occur when <i>Pacific Page Postscript plug-in cartridges</i> are used with this printer. Printer OK in PCL mode.</p> <p style="text-align: center;"><i>(New Info)</i></p> | <p>The problem has been identified down to the NVRAM page count of the LJ11P caused by the Pacific Page PS Cartridge. This page counter does not increment using this PS cartridge. It seems when the counter reaches 2047, for some reason the PS Cart believes it has a Legal paper size installed. This is why print image moves down the page.</p> <p>CE's have in the past replaced both Formatter and DC Controller PCA's, this will fix in the short term, but will fail again when the page counter reaches 2047.</p> <p><i>This is NOT a HP problem, the customer MUST contact Pacific Page.</i></p> <p>A temporary workaround is:</p> <ol style="list-style-type: none"> 1. <i>Reset page counter to zero via Service Mode, remove Pacific Page PS cartridge to do this.</i> 2. <i>Use HP PS cart 33439Q or C2089A(LJ11P only)</i> <p>This problem should be resolved by now, but may show up occasionally.</p> |
| <p>LJ11P IMAGE MOVES DOWN page by Approx. 3 inches. This problem can occur when <i>Pacific Page Postscript plug-in cartridges</i> are used with this printer. Printer OK in PCL mode.</p> <p style="text-align: center;"><i>(New Info)</i></p> | <p>The problem has been identified down to the NVRAM page count of the LJ11P caused by the Pacific Page PS Cartridge. This page counter does not increment using this PS cartridge. It seems when the counter reaches 2047, for some reason the PS Cart believes it has a Legal paper size installed. This is why print image moves down the page.</p> <p>CE's have in the past replaced both Formatter and DC Controller PCA's, this will fix in the short term,</p> |

LJ11P / LJ111P - POSTSCRIPT PROBLEMS (Con't)

| | |
|----------------|--|
| <p>(Con't)</p> | <p>but will fail again when the page counter reaches 2047. <i>This is NOT a HP problem, the customer MUST contact Pacific Page or Dealer.</i> A temporary workaround is: <i>1. Reset page counter to zero via Service Mode, remove Pacific Page PS cartridge to do this.</i> <i>2. Use HP PS cart 33439Q or C2089A(LJ11P only)</i> This problem should be resolved by now, but may show up occasionally.</p> |
| | |



HEWLETT
PACKARD

LaserJet / LJ2000
Troubleshooting Guide

Classic Printers

LaserJet 2000

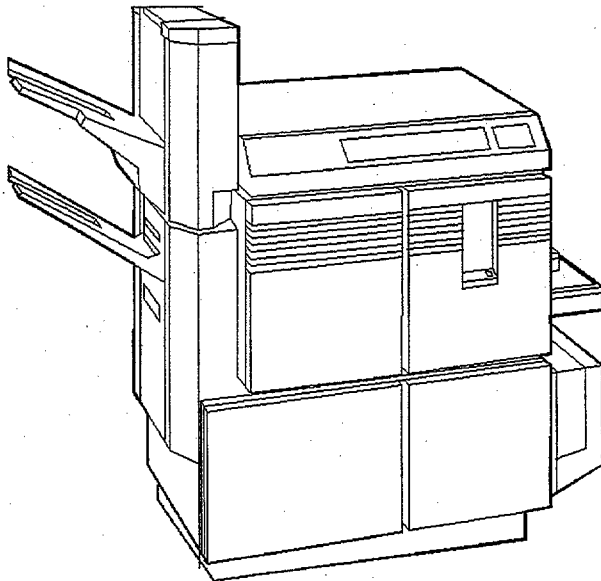

2684A/P/D

How to use this Section:

The faults are sub-divided into the following four categories

- 1) *Faults with Error Numbers*
- 2) *Miscellaneous Faults, i.e. front panel hangs, pages out of sequenc, etc*
- 3) *Print Quality Problems*
- 4) *Paperpath Problems, i.e. paper jams (surprise, surprise, this is the biggest section)*

PLEASENOTE:

When looking for 13.X Paper Jams please refer to paper path section, as all of these types of errors appear there.

JUMBOJET FAILURES (REAL ONES) WITH SOLUTIONS...

The faults contained in this section are ALL real fault that have actually occurred in the field. This booklet will help prevent other CEs going through the same logical troubleshooting path, thus saving time and increasing efficiency.

Note this is NOT a replacement for the 2684 TROUBLESHOOTING GUIDE Chapter.7 in the Service Manual, but can be used in parallel to aid fault location.

Please note all page references are for the NEW SERVICE MANUAL(02684-90903).

LIST of SERVICE NOTES up to Jan 91

Here are the Service Notes which have been released on the Jumbo to date:

- 2684 -1 Centronics I/O data loss
- 2 PDX Unit Improvements
- 3 Drum Damage Service Hints
- 4 Switchback Service Hints
- 5 Duplex Unit Improvements
- 6A Fuser Assembly Improvements
- 7 Switchback Unit Improvements
- 8 Drive chain and gear wear
- 9 Out of focus laser failures
- 10 Switchback - Friction / Positive drives
- 11 Font Cartridge Magazine mod
- 12 Front Panel Key Cap Replacement
- 13 Duplex Holding Tray LED
- 14A Toner Waste LED

Here is a list of items which you should also have available when going onsite:

SERVICE MANUAL..... 02684-90903 (2nd edition complete)

PAPER SPECIFICATION GUIDE...5954-8953

REAM of standard white Laser Quality photo-copier paper. (*Xerox 80 premier has always worked well with these printers*)

Order up several copies of the paper spec guide for the office and give a copy to customers with paper problems. Remember to ***always test out the printer with standard white Xerox 80 photo-copier paper*** whenever the customer's paper is suspected.

Other documentation:

OPERATOR'S MANUAL.....02684-90901

TECHNICAL REFERENCE.....02684-90904

2684 - FAULTS WITH ERROR NUMBERS

Please Note that all Paper Jams or Error 13.x problems, refer to the Paper Path part of this section of this manual.

| | |
|--|--|
| <p>10.1 PRINTER DOOR OPEN (when door are actually closed) When opening LH door get Error 62.</p> | <p>The DC Controller PCA had been replaced, <i>connectors J-124 on the DC Ctr PCA and J902B on the DFD PCA had been reversed.</i> <i>BEWARE this is easily done.</i></p> |
| <p>10.2 OUTPUT DOOR OPEN</p> | <p><i>Microswitch bracket bent at rear of the switchback Feeder Assy (i.e. open door on LHS to reveal fuser rollers). The microswitch in question is on top towards the back (or on the left of the switchback, looking into the fuser area). See service note on SWITCH-BACK UNIT IMPROVEMENTS(2684-4), this advises to order a door guide (p/n RA1-7035-000CN).</i></p> |
| <p>11.3 ADD PAPER - to paper Deck</p> | <p>1. Invalid paper size selected on PD/DU dip switches. The only valid sizes are: LETTER- SW3 1 (UP) A4-SW3 0 (DOWN) SW4 1 (UP) SW4 1 (UP)</p> <p>2. DCPSI in the PDX was tripping when the tray lifted to its working height. (The button was popping up). The cause was a faulty PDX DRIVER PCA (also known as a Deck Unit Control PCA).</p> |
| <p>Using PDX Tray, 13.1 Paper Jams, often preceded with 25.3 MISPRINT. Failure occurs when PDX runs out of paper of the door is open.</p> | <p><i>Switches Sw1-5 & Sw1-6 on the PD-DU Controller PCA are left in the UP(Active) position. These switches are used to locate Duplex jams (page 7-59) and should be normally DOWN (OFF).</i></p> |
| <p>ERROR 25.3 - MISPRINT (Intermittent)</p> | <p>Customer using paper with perforations. The perforation area was thicker than the rest of the paper and falsely reported a misprint.</p> |
| <p>ERROR 51-BEAM DETECT DETECT MALFUNCTION on power-up</p> | <p>Has the printer just been installed after having being moved from a cold environment? If yes, wait 30 minutes for printer to warm up and try again.</p> |
| <p>ERROR 51-BEAM DETECT MALFUNCTION (Intermittent)</p> | <p>1. Foldback mirror out of adjustment. Perform adjustment as per the Service Manual page 6B-28. 2. Foldback mirror had slipped out of adjustment due to one of 2 metal/rubber discs moving out of position. These disc are glued onto the the mirror mount (item 52, Fig 8A-04,P 8A-18) one is under the adjustment screw, the other (lower one) acts as a (Con't)</p> |

2684- FAULTSWITH ERROR NUMBERS (Con't)

| | |
|---|--|
| <p>(Con't)</p> | <p>backstop for the mirror mount. The fix in this case was to re-glue the lower disc in the correct position. Use RF PROBE(34301A) with DVM to adj , see instructions for its use in Appendix B-1 at the end of this section. <i>It has found by experience replacing the Foldback Mirror mount assy provides the long term fix, as glueing rubber discs's have not proved to be to successful.</i></p> |
| <p>ERROR 53 - OVERTEMP? After printer is switched off then on again. Several pages will be printed before this error occurs.</p> <p><i>(New Info)</i></p> | <p><i>The problem was caused by a Defective FM5 fan.</i> This fan blows air through the Primary Corona in order to keep wires free from contamination. Also if this fan is inoperative hot air will NOT be pulled from foldback mirror (via the laser tunnel)and laser unit. This causes the laser to overheat. This fan is accessed from the front of the printer behind thelarge black plastic guard below mirror.</p> |
| <p>ERROR 54-DRUM MOTOR MALFUNCTION</p> | <p><i>Faulty MOTOR DRIVER PCA.</i></p> |
| <p>ERROR 56 - Image Counter Malfunction</p> | <p><i>Faulty DC CONTROLLER PCA.</i></p> |
| <p>Will not pick-up from Paper Trays or PDX, also Intermittent ERROR 57 (Duplex Counter) <i>(Graham Jones - B'ham)</i> <i>(Oct 94)</i></p> | <p><i>Replacing the PD/DU PCA resolved this pbm.</i> The trick here was to disconnect the PDX & Duplex units from the print engine. Now try again, will it pick paper from paper cassette trays?</p> |
| <p>ERROR 58 O/P UNIT FAILURE. Only occurs when paper moves from a I/P tray. Stacker O/P tray jammed at the top of its travel, only 2.5cm of text is printed.</p> | <p><i>Worn shank on brass gear bearing on the nearside lifter assy drive shaft, item 26 Fig 8b-8, page 8b-15 (p/n RS1-0078-000CN), causing stacker tray to seize.</i> This meant that the tray could not initialise by dropping the required 1/2 inch.</p> |
| <p>ERROR 60 - Printer AC power Line UNSTABLE.</p> | <ol style="list-style-type: none"> <i>1. J109 connector on DC CONTROLLER PCA not connected.</i> <i>2. Faulty DCPS1 (See Fig 9-1, p 9-3 for location.</i> <i>3. Faulty SLAVE CPU PCARG1-0513-040CN.</i> |
| <p>ERROR 62 when opening LH side door. 10.1 Printer Door Open message was first to appear even though door was actually closed.</p> | <p>The DC Controller PCA had been replaced and <i>connector J-124 on the DC Ctr PCA and J902B on DFD PCA had been reversed.</i> BEWARE this is easily mistakenly done.</p> |

2684 - FAULTSWITH ERROR NUMBERS (Con't)

| | |
|---|---|
| ERROR 70 - System Fault (06FF) (<i>Intermittent</i>) | <i>Faulty FORMATTER PCA.</i> |
| ERROR 70 (160F) intermittent? (<i>New Info</i>) | The Formatter Power Supply +5v was found to measure 4.5v. <i>This DC Voltage was reajusted to +5v and problem</i> did not recur. NOTE: any problems in the Formatter area it is always worthwhile checking this voltage. |
| ERROR 74 - Local RAM Malfunction (<i>Intermittent</i>) | <i>Faulty FORMATTER PCA.</i> |
| ERROR 79 when downloading Macro's. (H Thorsagan - Norway) | <i>Using Non-HP memory chips</i> |

2684 - MISCELLANEOUS Problems

| | |
|---|--|
| <p>Self-Test HANG, no errors or Paper Jam reported.</p> | <p>Printer was in CE MODE and hence did not report an Error 50 (or else the CE did not see the message flash up as CE mode tried to override the error condition). DO NOT LEAVE IN "CE MODE".</p> |
| <p>Difficulties obtaining LASER POWER after Laser Unit has been replaced.</p> | <ol style="list-style-type: none"> 1. For Laser Power Adjustment (p 6B-26), turn on DSW941-7 (Ready killer) BEFORE DSW941-2 (Laser-on) to avoid Beam fail. 2. Reconnect all plugs and switch on (NOT in CE mode) to see if there are any errors other than 51-Beam Detect Failure. A scanner motor failure for instance will override the READY KILLER and prevent the laser turning on. |
| <p>In Duplex, PAGE NUMBERING NOT SEQUENTIAL, i.e. page 1 on one side, page 20 on the other.</p> | <p><i>Faulty CENTRONICS INTERFACE PCA</i></p> |
| <p>IN Duplex, PAGE NUMBERING NOT SEQUENTIAL, i.e. page 3 on one side, page 6 on the other (Factor of 3 page difference?) A Blank sheet is always be a be in Vert Pass after print job is completed.</p> | <p><i>Faulty Double Feed Detect Assy, either requires adjustment or replacement.</i> This fault is caused by the DFD assy allowing 2 sheets of paper through EP Area (1st Pass) simultaneously. This ends up in the Duplex Holding tray undetected, thus giving this pbm Front sheet when compared to rear of same sheet will have a factor of 3 page numbers difference.</p> |
| <p>NO ERROR MESSAGE's. Three Paper Jam LED's in the DUPLEXER stay on all the time. (at installation)</p> | <p><i>Dip switches on PD/DU Controller PCA had been left in factory position - SW 1 & 2 on page 6H-13 were ON instead of OFF.</i></p> |
| <p>"TICKING" noise coming from Stacker Power Supply area. Can cause Duplex jams, Erratic movement of Stacker O/P Tray, LED G on LHS of Operators Front Panel can flicker.</p> | <p><i>Replace Stacker Power Supply.</i></p> |
| <p>POOR FOCUS, BLURRED PRINT, i.e. character fill-in on "e,m,a,b, d,o,q" etc. Bold fonts have blurred edges. Self-Test box 7 may appear light. Heavy shadows around characters.</p> | <p><i>Faulty Laser Assembly.</i> (assume HV and Laser adjustments have been carried out). Replace laser unit as per Service Note 2684-9.</p> |

2684- MISCELLANEOUS (Con't)

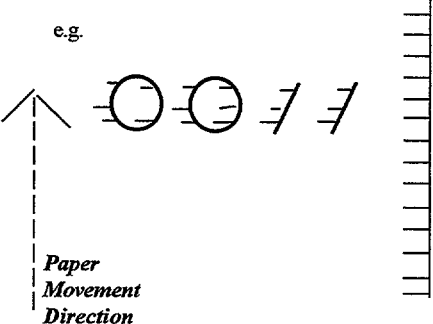
| | |
|--|---|
| <p>Intermittent DARK 2 inch Wide BAND OF Toner in Laser Scan direction. Occurs every 20-50 pages, edges of band are blurry and extends across the entire length of drum.</p> | <p><i>Faulty POTENTIAL CONTROL PCA.</i> The "ES LOOP" was running out of control causing the Primary Corona current to increase until it began to arc. TIP: Set SW1 on the mode select switches (P 6C-33) to OFF (right). This sets the Primary Corona control to NON-AUTOMATIC" mode, which keeps the current fixed at the initial (Vdark target) value.</p> |
| <p>STREAKY BACKGROUND Faint lines across page, approx 1/2mm apart. These lines appear in scan direction, but are not straight lines. They are slightly uneven and look very much like background.</p> | <ol style="list-style-type: none"> <i>1. Worn/dirty cleaner blade - reverse edge or replace.</i> <i>2. Replace Cleaner Station Assy.</i> |
| <p>HORIZONTAL Displacement LH PARTS OF ALL CHARACTERS (LANDSCAPE MODE). Chars are clearly formed (i.e. NOT fuzzy) but have distinctive LH tails (in this case a row at the top and bottom, and one in the middle). See Example opposite.</p> | <p><i>Faulty SCANNER MOTOR assembly.</i></p>  |
| <p>JAM INDICATOR AND PS4 LED on, accompanied by either: * 13.1 PRINT JAM (SIMP) * 13.3 DUPLEX JAM (DUP) * 56-MAIN COUNTER MALFUNCTION</p> | <p><i>Faulty DCPS1 in the print engine.</i> This symptom occurs when the 24v fails and hence sensors/counters etc. will become inoperative and give false readings. Check the 24v coming into the DC CTRL PCA at J101, pin 2; this comes direct from the power supply and if low then DCPS1 should be replaced. (Remember PS4 LED corresponds to the sensor above the PDX, and behind lower cassette holder).</p> |
| <p>Will not pick-up from Paper Trays or PDX, also Intermittent ERROR 57 (Duplex Counter) <i>(Graham Jones - B'ham)</i> <i>(Oct 94)</i></p> | <p><i>Replacing the PD/DU PCA resolved this pbm.</i> The trick here was to disconnect the PDX & Duplex units from the print engine. Now try again, will it pick paper from paper cassette trays?</p> |

2684- MISCELLANEOUS Problems (Con't)

| | |
|--|---|
| <p>At power displays '05 'as normal, does not Display 'WARMING UP', but jumps to '00 READY'? After completing warm up with incorrect display, printer works fine. If doors are opened (except front doors) there is NO door OPEN message. Also if PJ occurs, no PJ message is displayed though orange PJ light illuminates. Also if MISPRINT occurs no 25.x message appears, though paper does appear in Error Tray. <i>(Paul Kroon - Holland)</i></p> | <p><i>Replace Engine PCA.</i></p> |
| <p>HANGS ON-LINE in DUPLEX, no paper in holding tray, large green knob in Duplex continuously turning. Last pages on stacker has page numbering out of sequence.</p> | <p><i>Double Feed had occurred in Duplex. Drop holding tray & force 2 pages through the upper and lower separation rollers. If this can be easily achieved, these rollers are worn and should be adj'ed or replaced.</i></p> |
| <p>ERRATIC movement of O/P STACKER Tray. LH jam LED (stacker) on indicator display flickering. DUPLEX JAMS (as paper enters duplex from fuser). "TICKING" noise from STACKER POWER SUPPLY.</p> | <p>Faulty Stacker Power Supply (+24v). Verify by monitoring the +24v rail on the Stacker Control PCA (TP103). If supply is faulty then the voltage will dip to 15-21v when self-test is initiated, although it can measure +24v when the printer is idle.</p> |
| <p>FUSER TOWEL running out after 20-30K pages (220-240v)</p> | <p><i>A 10K 10 watt resistor (item 80, Fig 8a-03, page 8a-10) in parallel with fusing towel motor assy had gone O/C, causing the motor to run fast. This resistor is shown on the BASIC PRINT ENGINE diagram page 9-3, middle left of AC Driver PCA.</i></p> |
| <p>On power on, AC Mains Circuit Breaker TRIPS OUT (not printer cb).</p> | <p><i>10K ohm 10 watt resistor for Fuser Towel motor was shorting down to earth. This resistor is in parallel with Towel Motor.</i></p> |

2684- MISCELLANEOUS Problems (Con't)

| | |
|---|--|
| <p>MISPRINTS & multiple copies of the same printed pages appears in the O/P tray. ONLY with A3 paper.</p> | <p>Two sheets of A3 paper feeding simultaneously from Duplex holding tray. <i>Adjust or replace Separation rollers.</i></p> |
| <p>On Power on , goes to Ready as normal, then jumps to "05 Self-Test"?</p> | <p>CE noted 5v on Formatter Power Supply measured 4.7v, <i>readjusted to 5v fixed problem.</i></p> |
| <p>Print "CRACKING" when paper is folded. White lines may be seen running through characters where page is folded.</p> | <p>Toner comprises of pigmented plastic material and iron oxide. When subjected to high temperatures these individual plastic particles become part of a larger plastic image on the page. When the page is folded the plastic must give in some way. If the print image is well set into the paper , the resulting break in the plastic will NOT be very apparent. However, if the toner has NOT been able to penetrate the paper fibres, the "<i>Crack</i>" in the plastic image will be amplified. A white line will be seen through image.</p> <p>To Minimize:</p> <ol style="list-style-type: none"> 1. <i>Ensure paper meets ALL Paper Specs, see guide 5002-1801. In particular pay attention to the smoothness (100-250 Sheffield) and/or "Wax Pick" (>11 Dennison)</i> 2. <i>A lighter Density setting will ensure less toner , thus minimising the problem.</i> 3. <i>A lighter character stroke may also help</i> |
| <p>Self-Test will NOT run from Lower Paper Tray.</p> | <p>Check if lower tray is a "SECURE SOURCE" <i>Turn OFF secure source via front panel.</i></p> |
| <p>LEADING EDGE of Paper has toner SMUDGE, mostly on the rear side of page. Also image is SKEWED. <i>(New Info)</i> <i>(Ian Martin, B'ham, Jun 94)</i></p> | <p>If the leading edge was observed closely, from the rear of printer towards the front, the paper had picked up toner. This toner smudge appeared mainly on the rear side of page and gradually get worse towards the rear of the printer. Also the image is Skewed compared to the leading edge of the paper. <i>This problem was resolved by adjusting BLOCKS on item 66, page 8a-14, Fig 8a-4.</i> In this case the rear block was adjusted to resolve both the Toner Smudge and Skew problems.</p> |
| <p>Customer REFEEDING paper, not two sided printing?</p> | <p>As above refer to HP general statement on "<i>Duplex printing v Simplex</i>" in HP Reference Guide (Green Book) section 3.</p> |

2684- MISCELLANEOUS Problems (Con't)

| | |
|--|--|
| <p>PAPERJAMS/MISFEEDS/ SKEWING caused by customers practice of INTERLEAVING different types of paper in paper trays?</p> | <p><i>Interleaving, where a variety of paper is placed in the paper tray, is not recommended by HP. This practice is likely to lead to Paper jams & Misfeeds. For the general HP statement on "Interleaving Paper" please reference HP Reference Guide (Green Book) section 3.</i></p> |
| | |

2684 - PRINT QUALITY PROBLEMS

| | |
|--|--|
| <p>Repetitive Marks on the page, print defects at regular distance apart.</p> | <ol style="list-style-type: none"> 1. 50mm apart (<i>Registration Rollers</i>) 2. 50mm apart (<i>Duplex Rollers</i>) 3. 64mm apart (<i>Cleaning Assy</i>) 4. 100mm apart (<i>Developer Assy</i>) 5. 135mm apart (<i>Fuser Roller</i>) 6. 250mm apart (<i>EP Drum</i>) |
| <p>INTERMITTENT FAINT PRINT (1-15K pages) across entire page. Less frequently a BLACK page. is printed. (NEW Printer)</p> | <p><i>Fault was due to grounding problem with HVT1 which supplies TRANSFER (faint page problem) and PRIMARY (black page) coronas. Check the 4 LED'ss on HVT1; in this case D107, D106 & D207 were on but D206 always remained off. The lower left hand spring contact of item 73 (spring leaf), Fig 8A-03, p8A-13 was incorrectly positioned to the left of the corona guide (looking from the back). The fix was to remove the spring leaf and then reposition the LH spring contact to the right so that it is pressing against the corona guide.</i></p> |
| <p>Print FADES towards front of Printer?</p> | <ol style="list-style-type: none"> 1. <i>Cleaner Blade NOT SEATED properly.</i> 2. <i>Print Engine lower paper guide plate (item 67 Fig 8a-4, page 8a-14) was loose due to screw (E62) missing?</i> 3. <i>Check Height of Primary Corona wires adjust to correct.</i> |
| <p>FAINT AREA's on leading edge of Duplex page. (Approx 1/4 to 3/8 inch)</p> <p><i>(Duncan Frankland- Hat) (Freddy Olsen-Denmark)</i></p> | <ol style="list-style-type: none"> 1. <i>Caused by paper rippling after first page passes through Fuser for the 1st time. Try another type of paper.</i> 2. <i>Check EP Voltages & Drum Potentials.</i> 3. <i>Adjust Separation/Transfer corona wire height. or move Sep/Transfer Corona mounting guide to take corona closer to EP Drum. Refer to page 8a-14, the paper guide is item 67 which is attached to the Transfer frame item 66 by guide blocks item 69. There are 2 guide blocks, one at each end of transfer frame. To adjust the paper guide, loosen screws at each end of the Transfer frame, slide the block up or down and then retighten the screw. To get at the rear screw, take off the rear cover and lower Transfer/Sep Corona assy. BEWARE if adjusted to close to the EP Drum paper jams may occur.</i> |
| <p>Some Characters FAINT in Scan direction? (<i>New Info</i>)</p> | <p><i>Check Foldback Mirror adjustment or replace mirror mount.</i></p> |
| <p>BLOTCHY Background all over page?</p> | <p><i>Customer had put NON-HP toner (ie Xerox) into the Developer Assembly. Look at Toner coating on Dev Drum, it will appear either very uneven or will have a very thin coating</i></p> |

2684-PRINT QUALITY PROBLEMS (Con't)

| | |
|--|--|
| <p>BLACKPAGES.</p> <p style="text-align: right;">>></p> <p>(Ray Wambold, USA)</p> | <p>1. <i>Potential sensor was shorted</i> to it's mounting plate(item 62,fig 8A-04,p8A-18 by a metal burr. A quick test is to remove the one screw at the front which fixes the mounting plate and provides the path to ground (the screw is the one holding in plastic item 11, Fig 8A-02, p 8A-8). If the black pages disappear then remove potential sensor/plate assy and check for shorting burrs, fluff etc.</p> <p>2. DS106 on HVT1 HVPS dim or not lit, also LED1 & LED2 on Potential Control PCA not lit.</p> <p><i>This was caused by DCLPS2 Power Supply, no 5v to Potential Control PCA.</i></p> |
| <p>Prints completely BLACK PAGES with no white borders? (F. Van Grieken, Australia) (New Info, May 94)</p> | <p><i>Resolved by replacing Potential Sensing Assy.</i></p> |
| <p>BACKGROUND, prints slightly FUZZY?</p> | <p>Varistor on PRIMARY CORONA SCREEN was not grounded. Pull Primary Corona (No.1) out about 3 inches (7cm) and note the metal pins either side of the handle. The right-hand pin should engage a metal ground tab as the Corona is plugged in. In this case the metal tab had been bent and was not contacting the RH pin; <i>the fix was simply to bend the tab straight.</i></p> |
| <p>General BACKGROUND all over page? (Mike McGough - B'ham)</p> | <p><i>Replace Developer Assy.</i></p> |
| <p>BLANK PAGES running SELF-TEST (no errors, no image on drum. DC Cont PCA had just been changed).</p> | <p><i>Pins bent on J109 connector of the DC Controller PCA.</i></p> |
| <p>BLANK PAGES only in Graphics mode (Lotus) when connected to an IBM PC.</p> | <p><i>IBM PC had an old version of the PRINTER Driver</i></p> |
| <p>FUZZY MARK (5mm wide) recurring every 10.5cm in direction of paper path.</p> | <p><i>Foreign body had stuck onto DEVELOPER ROLLER.</i></p> |
| <p>DOTS REPEATED every 25cm in the direction of paper path (ie once per A4/LETTER size sheet but not in the same place). Dot size is unacceptable to the customer/CE.</p> | <p><i>Drum damaged (i.e. arcing). Ensure all coronas, HV and dev bias supplies are operating correctly and the EP area is free from excess toner before replacing the drum. NEVER run the printer with the developer empty. See service note on DRUM DAMAGE SERVICE HINTS (2684-3).</i></p> |

2684 - PRINT QUALITY PROBLEMS (Con't)

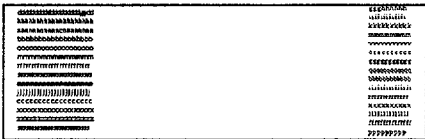
| | |
|---|--|
| <p>Recurring SMUDGE or mark every 10cm. This pattern could be seen in developer brush. Cleaning Developer would get rid of it for a while. Replacing developer gets rid of problem for a little longer. (Ed Rote, USA)</p> | <p>The printer was in a very warm environment and enclosed in a small area, with no air movement. This caused toner to CLUMP on the developer. <i>Ensuring there is adequate airflow to dissipate the heat fixed this problem.</i></p> |
| <p>In Scan Direction, from LH side prints Approx 75mm then blank, then prints the last 25mm. As print changes to no print, the printed image does fade. See example opposite.</p> | <p><i>Adjust Foldback mirror or replace mirror mount.</i></p>  |
| <p>CHAR's BREAKING UP EVENLY ACROSS THE PAGE. Eventually all that is printed is a jumbled series of broken scan lines running edge to edge of the paper.</p> | <p><i>Faulty ENGINE INTERFACE PCA.</i></p> |
| <p>55mm JITTER only with A3 or Ledger paper. Seems to appear when Shaded areas are printed. A smear appears 55mm from the trailing edge and is 2/3mm wide. (Hubert Villiers)</p> | <p><i>Replace with new Feeder guide Assy (RG1-1719-000CN)</i></p> |
| <p>Print Image MOVED DOWN page by approx 15mm? This was in the direction of paper movement. (New Info) (Peter Salesbury - City Gate)</p> | <p><i>Replace Main Motor. This motor must have been running slightly fast to give this symptom.</i></p> |
| <p>The Character Font on Self-Test look WAVEY, normally they should be diagonal.</p> | <p>Customer has a Proportional Plug-in font, similar to perhaps a 92286F font. <i>The printer always grabs the plug-in font rather than the normal internal font.</i></p> |
| <p>Characters COMPRESSED & ELONGATED, more noticeable when text is printed in landscape mode (in Paper Direction) (Chris Rivett)</p> | <p>It was noticed also, that in the small squares on the Self-Test has narrow darker bands approx 4/5mm apart. These bands were from front to back of printer. Removable of the EP Drum showed these lines which could not be removed by cleaning. <i>Replacing EP Drum resolved problem.</i> Initially this problem looks like Print Eng Chain or Main Motor, so BEWARE.</p> |

2684 - PRINT QUALITY PROBLEMS (Con't)

| | |
|---|--|
| <p>LEADING EDGE of Paper has toner SMUDGE, mostly on the rear side of page. Also image is SKEWED. (New Info) (Ian Martin, B'ham, Jun 94)</p> | <p>If the leading edge was observed closely, from the rear of printer towards the front, the paper had picked up toner. This toner smudge appeared mainly on the rear side of page and gradually get worse towards the rear of the printer. Also the image is Skewed compared to the leading edge of the paper. <i>This problem was resolved by adjusting BLOCKS on item 66, page 8a-14, Fig 8a-4.</i> In this case the rear block was adjusted to resolve both the Toner Smudge and Skew problems.</p> |
| <p>BOLD line across middle of page. (New Info) (Dave Duerden, Man, May 94)</p> | <p>This problem occurred from both paper cassttes. <i>The Print Engine Registration assy was replaced to resolve this problem.</i></p> |
| <p>OFFSET IMAGE appears on page after long print runs. (New Info) (Mike Collins, Bristol, May 94)</p> | <p>This only occurs after long continuous print runs. The customer print lines in the paper direction movement and in exactly the same position on the page repetitively. This problem is caused by the inability of the fuser assy cleaning towel to clear the offset image that will appear on the fuser rollers due to the image being placed repetitively in the same place. <i>There probably is no solution short of getting customer to vary their printing to ensure no repetitive lines are printed over a long period.</i> Ensure the following: 1. Cleaning towel does not require replacement. 2. Clean fuser rollers and apply silicon-oil. 3. Check for correct operation of towel assy.</p> |
| | |

2684 - PAPERPATH PROBLEMS

Paper jams which occur either in the DUPLEX or STACKER UNIT will almost certainly cause a jam in the PRINT ENGINE immediately afterwards. What this means is that (if your ears are sharp) you will hear 2 "pings" as the jam occurs; first the jam source will flash up (i.e. 13.3 DUPLEX JAM, or 13.2 OUTPUT JAM), then the secondary jam 13.1 PAPER JAM (i.e. print engine) will appear a few seconds later. This means that jams in the stacker and duplex can be difficult to detect unless someone is standing over the display panel at the moment the jam occurs to read the first message. **DO NOT** leave in CE MODE as to double ping will not occur. **YOU HAVE BEEN WARNED!**

Remember to use the DUPLEX TROUBLESHOOTING HINTS to determine if a jam is in the DUPLEX area, i.e. set SW5 & 6 on the PD/DU CONTROLLER PCA to "ON" - a display code of zero indicates jam is NOT in the DUPLEX, otherwise match the code to the Jam Location Table to find out where in the DUPLEX the jam was detected. See A1 at the end of this section .

2684 - PDX /Cassette Area

PAPER JAMS IN THE PDX PICK-UP AREA, i.e. paper skews as it is picked. Sometimes there is no jam but the print is skewed excessively on the page.

1. One of the silver corner tabs (in this case the LHS was sticking up. This caused a sheet of paper to twist around the raised tab instead of flicking over it as it is picked. To view these tabs open the plastic door, insert the inter-lock and as paper rises it will stop with the corner tabs resting on the two inner corners. *If these tabs are now raised they should fall freely onto the paper stack.* In this case the LH tab was binding against the paper stack and had to be bent away. These tabs are riveted to side plates 8 & 9 in Fig 8C-03 of the manual.
2. RH corner tab sticking up. Remove RH plate and insert a spring vertically from top of tab to indentation below. The bushing return spring from the Switchback upgrade (p/n FS1-2370-000CN) stretched out provided suitable tension.
3. Paper deck too high. The top sheet was touching the belts which drive the pick-up rollers which caused paper to skew as it was picked. *Perform the UPPER LIMIT TRAVEL adjustment on page 6H-43 to lower paper deck.*
4. Paper deck too low. The top sheet is not snugged up to the silver corner tabs but lies a short distance below. This causes paper to skew round the RH tab. *Perform UPPER LIMIT TRAVEL adjustment to raise the paper deck (Page 6-129).*

PDX / Cassette Area (Con't)

| | |
|--|---|
| <p>PAPER SKEWS/Paper Jams intermittently FROM PDX approx every 50-500 pages.</p> | <p>Uneven tension between PDX registration rollers due to a loose pivot pin plate. Fig 8C-03, page 8C-9, screw K63 which secures item 14 was loose. The problem was rectified by tightening the screw. <i>Adjust Tension of Roller Chain</i></p> |
| <p>PAPER JAM IN PDX using 3 & 4 Holed Paper.</p> | <p><i>The LJ2000 does not support paper with cutouts</i> Problems occur when paper is loaded in the PDX with the holes to the left. Marginal success MAY be obtained using cassette trays.</p> |
| <p>PAPER JAM when using PDX or DUPLEX (paper jams in feed rollers of PDX).</p> | <p>1. The PDX FEED ROLLER CLUTCH outer casing had jammed. Try turning the feed rollers by hand. If they are stiff then either the feed roller clutch (blue plug) or brake clutch has seized. <i>The fix is to ensure S/N 2684-2 is implemented, new style clutches and PD/DU firmware, was rev 07 is now Rev 08.</i> 2. When Feed and brake clutches were replaced together, the <i>CE installed these clutches in the wrong position.</i> (i.e. feed clutch was in the Brake clutch position and visa versa)</p> |
| <p>Using PDX TRAY, 13.1 PJs, often preceded by 25.3 MISPRINT, Failure occurs when PDX runs out of paper.</p> | <p>Switches SW1-5 & SW1-6 on the PD-DU Controller PCA are left in the UP (ACTIVE) position. These switches are used to locate Duplex jams (page 7-59) and <i>should be normally DOWN (OFF).</i></p> |
| <p>Print image appears SKEWED or PAPER JAM 13.1 occur from PDX ONLY. <i>(Vic Beveridge - SQF)</i></p> | <p>The movable plate the paper is loaded onto in the PDX was bent on the LHS, this appeared to make the elevator chain slacker on that side. <i>Straightening of this plate corrected problem</i></p> |
| | |

2684 - FDS (Stacker) Area

| | |
|---|---|
| <p>PAPER JAM IN UPPER STACKER, WITH PAPER ENTERING MAIN TRAY. Occurs during paper path test and MISPRINT</p> | <p>The paper had been incorrectly sent to the MAIN TRAY instead of the ERROR tray. This was due to the SUB TRAY DEFLECTOR SOLENOID (SL4) not functioning properly. <i>Re-seating this solenoid solved problem.</i></p> |
| <p>PAPER JAM IN UPPER STACKER. The leading edge stops just short of the delivery rollers items 9, page 8B-15).</p> | <p>Upper paper tension springs, items 35,p 8B-10 were not strong enough causing paper to be insufficiently gripped by upper stacker drive rollers (items 23 & 36 on page 8B-12). Lift stacker top and pull jammed sheet through, there should be some drag caused by the rollers.</p> |
| <p>FACE DOWN STACKER JAM 13.2 paper stops just before it arrives at PS4 in the upper stacker area.</p> <p><i>(Lee Williams-Billericay)</i></p> | <p>After leaving the fuser assy, it was found that the paper was slowing down considerably in the FDS. Roller shaft Item 67 on page 8b-22 is driven by a Spring loaded Clutch via a drive belt. This clutch has rubber washers which had perishes. After cleaning bearings and replacing rubber washer, operated correctly. <i>Refer to page 7-20 for more detail.</i></p> <p>1. Replaced rubber washers RS1-6021-000CN item 35 page 8b-22 and Clean clutch and bearing.</p> |
| <p>PAPER JAM 13.1 in FDS. Paper begins to exit fuser but not picked up by switchback and crumples.</p> | <p>Switchback feeder motor M2 not moving due to low +24v at this motor. <i>Faulty Switchback Control PCA.</i></p> |
| <p>"TICKING" Noise coming from STACKER area.</p> | <p><i>Replace FDS Stacker Power Supply.</i></p> |
| <p>Paper appearing in FACE-UP mode in O/P stacker in SIMPLEX mode. Paper should, in simplex mode, go down into the Switchback, then up to the O/P stacker.</p> | <p>Deflection shaft seized, <i>due to grease in bearing congealing, cleaned then OK.</i></p> |
| <p>PAPER JAM IN FACE DOWN STACKER. Paper never enters Sw/back. With covers off, all shafts in upper portion turn very slowly.</p> | <p>Faulty FDS CONTROL PCA. Although 5v was coming from the power supply, <i>there was no 5v on the Stacker Control PCA. Replace this PCA</i></p> |

FDS (Stacker) Area (Con't)

13.2 Paper Jam as paper begins to exit delivery rollers at the top of the stacker assy.
(New Info)

Delivery clutch had seized (Item 16 page 8b-12, P/N RH7-5007-000CN). This is CL1 Delivery Roller Clutch. This clutch can also be noisy and may be the cause of stacker power supply failure *Replace this clutch, this is known to be a common failure in this printer.*

2684 - FDS (Switchback) Area

| | |
|---|---|
| <p>13.2 PAPER JAM WHEN PAPER is DIRECTED TO ERROR TRAY, i.e. during a MISPRINT.</p> | <p><i>Damaged female pin on J55 in fuser area. Locate the 2 fixing screws which secure the fuser assembly; you will see 2 molex connectors to the left of the LH screw screw, viewed from the side (see Fig 6C-89, p6C-79). J55 is the larger connector (3x5).</i></p> |
| <p>13.2 PJ's in SWITCHBACK can be intermittent. Paper can be dumped into the bottom of the Duplex area.</p> | <p>Reverse SL6 Solenoid slow in operation, if paper does not reverse it will drop into bottom of Duplexer.</p> <ol style="list-style-type: none"> 1. <i>Replace Reverse Solenoid (SL6).</i> 2. <i>Check possibility that PS7 sensor flag is sluggish as entry at bottom of this page ("13.2 Paper Jams")</i> |
| <p>13.2 Paper Jams in SWITCHBACK , can cause skewing of paper in the Deflector Roller areas (Friction Drive) (Geoff Banks - Preston)</p> | <p>On inspection the Deflector Solenoid does not appear to release or engage quickly enough? Rubber Sleeves on Deflector Rollers had migrated to LHS and was binding. <i>Replace Deflector shaft in switchback.</i></p> |
| <p>13.2 PJ's IN SW/BACK (i.e. OK in DUPLEX mode) Paper skews as it enters the switch-back; as it reverses direction it jams in the top LH corner (viewed from the side).</p> | <p>Read service note on SWITCHBACK SERVICE SERVICE HINTS (2684-4). Briefly:</p> <ol style="list-style-type: none"> 1. <i>Check the SL5 (s/back deflector) solenoid adjustment (p 6G-52) for 2 mm gap.</i> 2. <i>Clean perspex rollers with alcohol, rubber ones with a damp, lint-free cloth (remember SM4 on Bonsai's).</i> 3. <i>Ensure rollers 64 and 11 (Fig 8B-10 2 of 2) are free to move in their frame holes. Remove burrs and lightly grease. If all else fails perform upgrade by replacing bearing hanger springs (2) and bushing return springs (2) and adding a washer to each end of deflector shaft. p/n RS1-2213-000CN, FS1-2370-000CN, and 3050-0893, Service Note 2684-4).</i> 4. <i>If all these fail and the printer has a friction drive switchback, upgrade to a positive drive switchback as per Service Note 2684-10.</i> |
| <p>13.2 Paper Jams intermittent. two sheets of paper in Switchback, a crumpled sheet exiting fuser, a sheet under EP Drum, lastly a sheet just leaving PDX. (Bob Haggett - Basingstoke) (New Info)</p> | <p>It was noted after long observation that PS7 sensor flag was slightly slow in snapping back to its home position after paper has passed by. <i>Dismantling this assy and cleaning with alcohol resolved problem.</i> Also check flag has not been worn by the constant passage of paper.</p> |

Note: *See Page 5-38 for detailed differences between Friction and Positive drive Switchbacks.*

2684 (FDS) Switchback Area (Con't)

13.2 PAPER JAM IN Switchback (OK in DUPLEX mode)
 Paper enters switchback correctly, but instead of reversing, paper is driven down onto the floor of the Duplex unit.

The signal from PS7 (lower switchback feeder sensor) was shorted giving "no paper" all the time. When paper entered Sw/back the roller reverse solenoid SL6 would activate and go off immediately when it sensed the "no paper" condition. *The short, in this case, was in the cable traversing the FDS (not numbered in the manual but between items 25 & 26 in Fig 8B-06 (p/n RF1-1146-000CN).*

13.2 PAPER JAMS in Switchback (Positive Drive).
 Seemingly insufficient friction as it passes through 3 driven Rollers.
 (Tim Webster Cen-Lon)

The fix was due to a disintegrating washer, refer to page 8b-22 item 67 (Roller Shaft/Roller), it can be seen it consists of 2 rubber washers & 4 carbon keyed washers and 1 free running gear, a compression rollers spring & a retaining collar (This assy acts as a clutch). This disintegrating washer causes this clutch to slip, thus 13.2 paper jams. *Replace rubber washers, see below: NOTE the diagram below does not appear in Service Manual.*

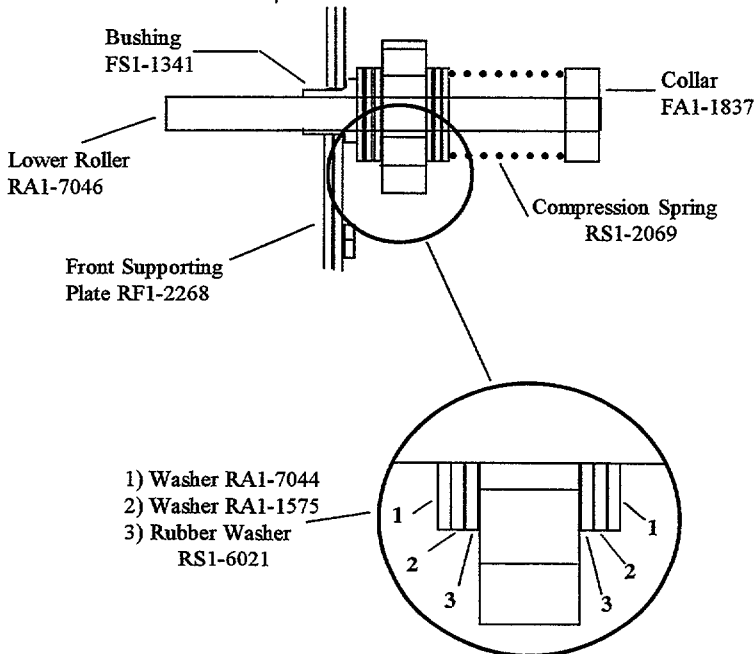

Note: See Page 5-38 for detailed differences between Friction and Positive drive Switchbacks.

2684 (FDS) Switchback Area (Con't)

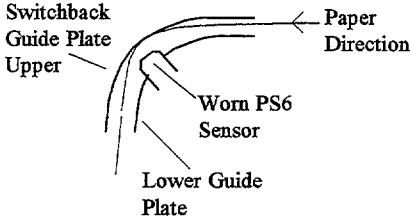
| | |
|---|--|
| <p>ERROR 13.1, paper intermittently will not enter switchback from Fuser. It is observed that when this condition exists, none of the rollers in the switchback move. <i>(Dave Malone - Manchester)</i></p> | <p>The 24v in FDS(stacker) was measured at 20v. <i>Replacing Stacker Power Supply fixed this problem.</i></p> |
| <p>13.2 then 13.1 Paper Jam (double ping) in switchback. <i>(Lee Williams - Billerica)</i> <i>(New Info)</i></p> <p><i>Diagram opposite shows how the paper can bypass PS6 sensor when the sensor flag is worn. Stiffer paper can also contribute.</i></p> | <p>To troubleshoot disable Paper Jam on Stacker Control PCA, if jam does not occur then electrical/sensor problem. In this case no paper jams occurred when PJ occurred. It was found that PS6 sensor flag was worn. As paper moved downwards into the switchback intermittently the paper would miss PS6 sensor flag due to the combination of wear of the flag and the bend the paper is trying to negotiate. This LJ2000 had printed 4 million images. Check also that SL5 deflector gap is set to approx 2mm. <i>To resolve this problem PS6 sensor/flag was replaced.</i></p>  <p>The diagram illustrates the switchback area where paper enters from the right and turns downwards. It shows the Upper Guide Plate, Lower Guide Plate, and a Worn PS6 Sensor. An arrow indicates the Paper Direction from right to left. The sensor is positioned to detect the paper as it turns, but the diagram shows the paper path bypassing the sensor due to wear and the bend in the paper.</p> |

Note: *See Page 5-38 for detailed differences between Friction and Positive drive Switchbacks.*

Note: *If you are experiencing persistent paper jam problems in the Switchback consider, if L2000 has "Friction Drive" switchback, upgrading to a "Positive Drive" switchback. See service note 2684A-10 for parts required.*

2684 - Duplex Area - Misc Problems

| | |
|---|---|
| <p>INTERMITTENT PAPER JAMS IN THE DUPLEX area? <i>(Refer to page 7-26 in Service Manual)</i></p> | <p>Only verified as DUPLEX jam (as opposed to a print engine jam) using the DUPLEX troubleshooting procedure, using switches 5 & 6 on the PD/DU PC in the PDX. The LED's indicated a 2nd Pass Pick-up jam, pointing to area 'D' (2nd Pass Feed Roller). <i>The fault was traced to a loose connection on SL1 2nd pass pick-up roller clutch (See 6I-56, 6I-44)</i></p> |
| <p>Cannot CLEAR DUPLEX JAM except by cycling the power, i.e. Duplex doors have no effect. When the doors are open in the READY state, there is NO ping or "10.3 Duplex door open" message.</p> | <p><i>Faulty PD/DU CONTROLLER PCA in the PDX.</i> The operation of the duplex door inter-lock was verified by monitoring JC101-3 on the PD/DU CONTROLLER PCA for 24v-door closed and 0v-door open.</p> |
| <p>PAPER JAM IN DUPLEX UNIT. Paper enters the holding tray and then DUPLEX JAM occurs.</p> | <ol style="list-style-type: none"> 1. <i>Faulty Separation/Feed Roller clutch CL1 (Fig 9-15, p 9-20). Confirm this by grounding J404 pin 1 on DU DRIVER PCA.</i> 2. <i>Customer using 3 hole paper.</i> Front hole aligns with the tray paper sensor giving false paper jam. See Mike Mclain's TWX on LJ2000 AND 3 & 4 HOLE PAPER. |
| <p>PAPER JAM 13.1 normally in DUPLEX mode. Two "pings" 13.3 to 13.1, paper in Vertical pass and under the EP Drum when PJ occurs.</p> | <ol style="list-style-type: none"> 1. <i>Replace Transfer/Separation Corona.</i> Due to the 2nd pass of the paper through the EP Drum area, paper not separating from drum. May occasionally PJ on 1st pass. 2. <i>Replace Pre-transfer Corona.</i> 3. <i>Replace HVT3 (PT/SE) Power Supply.</i> |
| <p>PAPER JAM IN DUPLEX UNIT. Paper jams in the Duplex prior to the holding tray (i.e. was not making it to the holding tray sensor).</p> | <ol style="list-style-type: none"> 1. <i>Faulty DUPLEX DRIVE MOTOR.</i> A mark was placed on the big green knob in the DUPLEX unit and the time to rotate was measured. The bad unit took 3 seconds to revolve, whereas a good unit takes 2 seconds. NOTE: by using the DC Controller PCA switches it is possible to feed paper to the holding tray. With a watch, time 5 rotations, take appropriate actions: <ol style="list-style-type: none"> a) <i>10 secs for normal good Duplex Motor.</i> b) <i>12 secs for Bad Duplex Motor</i> |

Duplex Area - Misc Problems (Con't)

| | |
|---|---|
| <p>MYSTERY PAPER JAM - (DUPLEX UNITS),i.e. When paper jams occur there is paper in the Print Eng & the Duplex unit, but no sheet is buckled. When the jam actually occurs there are 2 ‘pings’ instead of one. On inspection of the holding tray in the DUPLEX unit a sheet is found to be in there about 1" above the holding tray light sensor.</p> | <p><i>The weight is not operating correctly in the Duplex unit. Remove the SEPARATION UNIT with drive assembly (P 6I-46), turn the weight raising pulley CW and the weight should rise; CCW and the weight should lower. If the weight tends to stick up then inspect/ clean/ lubricate the torsion spring clutch (Fig 8D-05, items 8, 17, 23) which is probably slipping or else replace the entire drive assembly, P/N RG1-0434-000CN.</i></p> |
| <p>13.3 DUPLEX JAM -NO LED ON , but printer giving PAPER JAM, even after CYCLING POWER.</p> | <p><i>Paper under PS8 Duplex unit inlet paper sensor (Fig 6I-27, p6I-29).</i></p> |
| <p>13.3 DUPLEX JAM on Power-up? <i>(Andy Suett - Billercay) (Dec 94)</i></p> | <p><i>Replacing the Duplex Driver PCA(RG1-0547-000CN) resolved this pbm. The trick here is to disconnect the Duplex assy at PU/DU controller PCA or to disable Paper Jams using switches on the PD/DU PCA.</i></p> |
| <p>LED G (LHS) flickers on Operators Front Panel, causing false PJs intermittently. (See Fig 7-14 in Service Manual) or Stacker Power Supply can be heard to be "Ticking"? or Duplex PJ's can occur.</p> | <p><i>Replace Stacker Power Supply, +24v supply has failed or is failing.</i></p> |
| <p>RANDOM PAPER JAMS, SIMPLEX or DUPLEX</p> | <p><i>The engine drive chain had stretched to the point where the bottom section of the chain was interfering with the top section. See Service Note2684-8.</i></p> |
| <p>In Duplex mode paper creases in direction of paper movement This seems to occur between the EP Area and the Fuser assy. <i>(Lee Williams- Billercay) (New Info)</i></p> | <p><i>The gap between the transfer/Separation corona's and EP Drum is too close. This may be enough, with certain types of paper, to Skew the paper slightly. The result of this is, the paper enters the fuser skewed and this is when the creasing occurs. The paper attempts to straighten itself up, but does not succeed, thus creasing. Adjust gap between Trans/Sep Corona & EP Drum, see page 7-14 of service manual. Note: If the gap is set too wide the leading edge of Duplex page can have light areas.</i></p> |

Duplex Area - Misc Problems (Con't)

| | |
|--|--|
| <p>In DUPLEX light area's of print on the leading edge of duplex page. (New Info)</p> | <p><i>Adjust Trans/Sep Corona & EP Drum gap</i> as per previous input. This gap is too wide causing this problem, see page 7-14 of service manual. The converse of this is true, if this gap is too tight, <i>creasing of the paper</i> in the direction of paper movement may occur.</p> |
| <p>IN DUPLEX, PAGE NUMBERING NOT SEQUENTIAL, i.e. page 3 on one side, page 6 on the other (Factor of 3 page difference?) Blank Page always be a be in Vert Pass after print job is complete.</p> | <p><i>Faulty Double Feed Detect Assy</i>, either requires <u>adjustment</u> or <u>replacement</u>. This fault is caused by the DFD assy allowing 2 sheets of paper through simultaneously. This ends up in the Duplex Holding tray undetected, thus giving this problem. Therefore this extra page in holding tray is fed through and accounts for this strange problem.</p> |
| <p>DUPLEX JAMS as paper enters Duplex area? Also Stacker Power Supply can be heard to be "ticking" or erratic movement of Stacker O/P Tray.</p> | <p><i>Faulty Stacker Power Supply</i>. Is power supply making a "ticking" noise? +24v normally fails.</p> |
| <p>PAPER JAM when using PDX or DUPLEX (paper jams in feed rollers of PDX).</p> | <ol style="list-style-type: none"> 1. <i>The PDX FEED ROLLER CLUTCH outer casing had jammed</i>. Try turning the feed rollers by hand. If they are stiff then either the feed roller clutch (blue plug) or brake clutch has seized. The fix is to remove the clutch, dismantle, clean with alcohol and replace. Alternatively, if there is excessive wear, replace the clutch. See service note on PDX UNIT IMPROVEMENTS, (2684-2) and order a new FEED CLUTCH (FH7-5055-040CN) & ROM kit (02684-67911). 2. Both feed and brake clutches were changed together but the fault was still present. Problem was due to the clutches being fitted in the wrong positions, i.e. feed clutch in the brake position, brake clutch in the feed position. <p>NOTE: <i>Firmware Revision of PDX CPU PCA is now Rev 08, not Rev 07 as service note 2684-02 states. Do not upgrade from 07 to 08 unless you have problems as outlined on page 5-31 "PAPER JAM's in Duplex and/or in Fuser area".</i></p> |

Duplex Area - Misc Problems (Con't)

| | |
|--|---|
| <p>PAPER JAMS in DUPLEX and/or in FUSER AREA. (In Duplex Mode). Leading Edge of Duplex page damaged, small nicks which line up with separation pawls in Fuser Assy.</p> | <p>Fault due to Revision 7 firmware in PDX. This revision stopped the PDX clutches seizing but also affects movement of paper through the PDX feed rollers, this caused the Duplex leading edge damage. Service Note 2684-2, gives details for Rev 7 to resolve PDX clutches seizing, but please note this does NOT affect all printers. <i>The fix is to install PDX firmware REVISION 8.</i></p> |
| <p>MISPRINTS & Multiple copies of the same printed page appears in the O/P tray. ONLY with A3 paper.</p> | <p>Two sheets of A3 paper feeding simultaneously from Duplex holding tray. <u>Adjust or Replace Separation rollers.</u></p> |
| <p>PAPER JAM IN DUPLEX MODE all the time with 13.1, possibly intermittent when in SIMPLEX MODE. (Updated)</p> | <p>The SEPARATION CORONA was not operating due to a shorted PRETRANSFER CORONA. Jammed sheet (remember these have a common HVPS supply) in separation area around the drum. <i>The fix in this case, was to clean the pretransfer corona</i> (A case for doing proper PM's!). Also note, other assy's that can cause this problem are: <ol style="list-style-type: none"> 1. <i>Transfer/Separation Corona.</i> 2. <i>PreTransfer Corona.</i> 3. <i>Associated HVPS (HVT3 PT/SE)</i> </p> |
| <p>13.1 Paper Jams in DUPLEX Mode ONLY? (Peter Salisbury - City Gate) (Oct 94)</p> | <p>Problem very intermittent, occurs every 15/250 pages. Paper under EP Drum & half way out of fuser into switchback. <i>The resolution was to replace the HVT3 Separation/Transfer HVPS.</i> Its a good idea to check the quality of paper being used.</p> |
| <p>Very intermittent 13.3 DUPLEX PAPER JAMS (New Info) (Bob Edwards -UKRC)</p> | <p>Extremely intermittently a sheet of paper was trapped by the Duplex paper weight as it returned to its upright home position. This problem was due to limited torque in the final exit roller which ejects sheet into the Holding Tray. <i>See Page 8-d10, item 77</i> This roller has a spring rubber washer clutch arrangement. There was not enough tension to provide enough torque to push paper onto the holding tray quickly enough to avoid occasional entrapment by the paper weight as it returns to its upright position.</p> |

Duplex Area - Misc Problems (Con't)

| | |
|---|--|
| <p>DUPLEX PAPER JAM'S. This occurs as paper exits the fuser assy to go down into the switchback on route to the Duplexer for its duplex pass. OK in simplex mode. <i>(New Info)</i> <i>(Tony Savage, Billercay, Jun94)</i></p> | <p>Observation highlighted the fact that the sheet that was being pulled into the switchback far too slowly, on its way to the duplexor for the sheets its duplex pass. This caused the sheet which was on its way up the the stacker to catch up and jam. Interestingly a Duplex Jam occured. <i>The resolution was to simply clean rollers in SwitchBack.</i> These are the set of 3 together, including the deflector roller (Page 8b-23, items 64,11, 67)</p> |
| | |

Duplex Area - 2nd Pass Paper Jams

| | |
|--|--|
| <p>Intermittent DUPLEX JAM 13.3 to 13.1 (Double 'Ping') One sheet of paper left in Vert Pass area at PJ. Interrogation of PD/DU switches shows 2nd PASS paper jam.</p> <p style="text-align: center;"><i>(Bob Edwards)</i></p> | <ol style="list-style-type: none"> 1. <i>Clean all roller in duplex area</i> 2. <i>Replace Separation Rollers</i>, use Torque gauge as described on page 6-140 in service manual to set correct tension to these rollers. 3. <i>Replace Duplex PSI sensor & flag.</i> 4. <i>Replace 2nd Pass/Reg clutches.</i> 5. <i>Holding Tray Roller Solenoid intermittent.</i> 6. <i>Replace Transmission box.</i> 7. CE may have installed <i>Waste Toner LED(Visible) in Duplex (Q1) sensor position</i>, this may work initially, but may give this error intermittently. |
| <p>PAPER JAM 13.1 normally in DUPLEX mode. <i>Two ("pings") 13.3 to 13.1</i>, paper in Vertical pass and under the EP Drum when PJ occurs.</p> | <ol style="list-style-type: none"> 1. <i>Replace Transfer/Separation Corona</i>. Due to the 2nd pass of the paper through the EP Drum area, paper not separating from drum. May occasionally PJ on 1st pass. 2. <i>Replace Pretransfer Corona.</i> 3. <i>Replace HVT3 (PT/SE) Power Supply.</i> |
| <p>13.4 PAPER JAMS</p> | <p><u><i>Ensure to Install LED's in replacement of the incandescent lamp in Duplex Holding Tray.</i></u> (see service note 2684DU-02).</p> <ol style="list-style-type: none"> 1. <u><i>Ensure the correct LED is installed</i></u>, CE's have installed Toner Waste LED in Q1 location, these will NOT work. The correct Duplex LED is infra-red (Invisible to the eye), the Toner waste LED is a red visible light. 2. <u><i>Ensure the Duplex LED adapter bracket is correctly installed and is NOT loose.</i></u> |
| <p>Intermittent 2nd PASS PJ's in Duplex mode.</p> | <ol style="list-style-type: none"> 1. <u><i>Check if Infra-Red(invisible light) LED installed in Q1 position.</i></u> (service Note 2684DU-02)***** 2. <u><i>Check if LED Adaptor is not loose.</i></u> 3. <u><i>Check Separation Roller Not worn or Adjustment is required.</i></u> |
| <p>Intermittent PJ in the DUPLEX area.(2nd Pass Pick-up jam)</p> | <ol style="list-style-type: none"> 1. <u><i>Loose connection on SLI Second Pass Pick-up roller Solenoid</i></u>, Fig 6-156, page 6-135. |
| <p>INTERMITTENT DUPLEX JAM 13.3 FOLLOWED BY 13.1 Using Duplex troubleshooting procedure, a 2nd pass pick-up jam is decoded. Typically a single sheet may be left in Vertical Pass area. Printer has in excess of 2 million duplex images.</p> | <p><u><i>Worn Upper / Lower Sep rollers.</i></u> To test insert sheet from holding tray, should not be able to push paper through Sep rollers. Replace rollers or adjust as procedure in new service manual, page 6-139 & 6-140</p> |

Duplex Area - 2nd Pass Paper Jams (Con't)

| | |
|---|--|
| <p>13.3 to 13.1 "Double Ping" Paper Jams, <i>Very intermittent</i>. Replacing the Transmission Drive Assy (RG1-0434-000CN) appears to fix the problem for several weeks.</p> <p><i>(Bill Howitt - Aberdeen)</i></p> | <p>Observe the weight in the Duplexer, <i>are there any slight collisions</i> that could retard to movement of the paper? This proved to be the problem in this case, it slowed the paper sufficiently to make it late arriving at Q1 (LED) sensor.</p> <p>Remove Duplex assy, manually operate the weight, it should rise & fall smoothly. <i>If it "Shudders" replace Duplex Paper Feed Assy (RG1-0441-210CN)</i>. Its expensive, individual linkage parts are numerous and very difficult to obtain, if at all.</p> |
|---|--|

Duplex Area - I/P Jam

| | |
|---|--|
| <p>13.3 to 13.1 "Double Ping" PAPER JAM in Duplex mode only. Can be intermittent. Interrogation of the the Front Panel via PD/DU switches shows a Duplex I/P Jam.</p> <p><i>(Bob Edwards)</i></p> | <p>Observation highlighted the fact that SL7 (Deflection Solenoid, Switchback) was engaging, but very slowly, therefore NOT deflecting paper into the Duplexer. The RESTRICTED movement of the was caused by Guide Plate, item 7 page 8b-19, binding on deflector shaft, item 7 page 8b-22. The top portion of this Guide Plate was binding on the LHS of Switchback. <i>The fix was to simply bend the plate away from shaft.</i></p> |
| <p>PS8 Flashing, then ERROR 13.3 DUPLEX JAM.</p> | <p><i>Faulty PS1 in the Duplex unit</i> (see Fig. 6I-7, p6I-11 for sensor locations).</p> |

2684 Print Engine Area

| | |
|---|---|
| <p>13.1 PAPER JAM - NO PAPER in the printer and NO LED ON, but printer giving paper jams, even after cycling power.</p> | <p>PS1 paper sensor (just left of the drum) was TRUE, <i>due to the plastic guard on the TRANSFER/SEPARATION CORONA become detached and wedging itself between drum and sensor.</i> NOTE: PS1 and PS8 Duplex unit inlet sensor are the only sensors which do not automatically turn ON an LED on front panel when they are TRUE. <i>Removing plastic guard and either relocating or replacing resolved this problem.</i></p> |
| <p>PAPER JAM, 25.3 followed by a 13.1 PJ? Only occurred from Lower Paper Tray, no paper was found in printer paper path. <i>(Bob Hislop - Glasgow)</i></p> | <p>Paper out incandescent bulb in lower cassette tray was unlit. The printer attempted to pick another sheet from this tray after paper ran out, causing problem described. <i>Replace Lower cassette bulb.</i></p> |
| <p>PAPER JAM 13.1 ? paper begins to exit fuser but appears not to be picked up by the switchback correctly. Paper Crumples at this point. <i>(Updated)</i> <i>(Steve Goldstone- Man)</i></p> | <p>Stacker motor not moving, due to low +24v at M2 motor. 1. Replace Stacker Control PCA. If this does not work replace: 2. Stacker Motor 3. Stacker Power Supply</p> |
| <p>PAPER JAM 13.1 normally in DUPLEX mode. Two "pings" 13.3 to 13.1, paper in Vertical pass and under the EP Drum when PJ occurs.</p> | <p>1. Replace Transfer/Separation Corona. Due to the 2nd pass of the paper through the EP Drum area, paper not separating from drum. Note: May occasionally PJ on 1st pass. 2. Replace Pretransfer Corona. 3. Replace HVT3 (PT/SE) Power Supply.</p> |
| <p>RANDOM PAPER JAMS, SIMPLEX or DUPLEX</p> | <p><i>The engine drive chain had stretched to the point where the bottom section of the chain was interfering with the top section. See Service Note 2684-8.</i></p> |
| <p>13.1 PAPER JAMS, but paper clears printer before jams occurs? <i>(John Watson - Aug 93)</i> <i>(New Info)</i></p> | <p>It was also noted that the gap between paper moving through print Engine increased. <i>Replacing Stretched Chain and associated gears/cogs at rear of print engine resolved problem.</i></p> |
| <p>13.1 PAPER JAMS, unable to clear except by switching printer OFF then ON again.</p> | <p>Faulty RH door Interlock switch. DC Controller was not reset when door was opened/closed, which is necessary when clearing PJ's.</p> |

2684 Print Engine Area (Con't)

| | |
|---|--|
| <p>PAPER JAMS in DUPLEX and/or in FUSER AREA. (In Duplex Mode). Leading Edge of Duplex page damage damaged, small nicks which line up with separation pawls in Fuser Assy.</p> | <p>Fault due to Revision 7 firmware in PDX. This revision stopped the PDX clutches seizing but also affects movement of paper through the PDX feed rollers, this caused the Duplex leading edge damage. Service Note 2684-02 gives details for Rev 7 to resolve PDX clutch seizing problem, but please note this does NOT affect all printers. <i>The fix is to install PDX firmware REVISION 8.</i></p> |
| <p>PAPER JAMS / SKEWS as paper EXITS the DRUM area. Occurs about every 5 sheets from PDX, very intermittent from lower tray, no PJ's from upper tray?</p> | <p><i>Small, hard rubber substance stuck to one of the REGISTRATION rollers. Removing resolved problem.</i></p> |
| <p>PAPER JAMS BETWEEN FUSER & DRUM. Paper pauses or twists just before entering the Fuser rollers. Most times paper stops prior to Fusing rollers, but occasionally a sheet is partly in the fuser or halfway in the Stacker assy.</p> | <p><i>The lower paper guide was found to have "pips" of solid toner on the ridges of the guide. These were only visible when the guide was removed & held to the light. As the paper entered the Fuser the leading edge would catch on these "pips" slowing the progress of the paper down or twisting it. (see item 29, Fig 8a-36, page 8a-69)</i></p> |
| <p>In Simplex mode 13.1 PAPER JAM under EP Drum area, every 2nd or 3rd page.</p> | <p><i>Registration Clutch stiff, in this case clutch was cleaned & oiled. Replacing this clutch may be necessary.</i></p> |
| <p>FALSE PJ's in FUSER AREA, Intermittent Flickering of PS3 front panel LED.</p> | <ol style="list-style-type: none"> 1. Fuser PS3 sensor is mounted on moveable bracket and can be adjusted to prevent false sensor pulses. <i>Remove fuser and adjust the sensor plate</i> so the paper flag moves into the sensor without paper in the sensor. 2. Excess rubber on rollers of Delivery roller shaft (see Fig 8A-27, item 30). The eccentric rollers intermittently activate the paper jam circuitry. <i>A flat file can be used to remove the excess rubber.</i> |
| <p>Intermittent CREASES down page in direction of paper movement direction, also slight skew of paper can be observed as paper transits from EP area to Fuser assy? Most noticeable in DUPLEX. <i>(New Info)</i></p> | <p><i>By adjusting gap between Transfer/Separation Corona and EP Drum resolves this problem.</i> This gap is too close and may differ from front to back of printer. In this case the gap was too close at front of printer causing paper to slightly skew and therefore fed to fuser with this skew. Fuser assy tried to straighten paper, thus the crease developed down the page.</p> |

2684 Print Engine Area (Con't)

| | |
|---|---|
| <p>ERROR 13.1, error ping is heard but paper continues to move. Leading sheet stops in delivery roller area of FDS. Occurs with customer printing of Self-test. There is a 2nd sheet and this stops with 50 to 75mm under EP Drum? <i>(New Info)</i></p> | <p>It was noted that PS3 (fuser sensor) never lit as paper passed through fuser area. (LED B) <i>Fuser PS3 flag found to be misaligned, by correcting, this resolved customers problem.</i> Take care when troubleshooting this problem as one can be easily misled. The problem seems to be non-movement of the FDS Delivery rollers. Believe what you see and hear, in this case a 13.1 PJ occurred well before paper reached Delivery rollers.</p> |
| <p>ERROR 13.1 paper jam with front panel LED "D" on. No paper was found in Vertical Pass assy? <i>(Bob Haggett - Basingstoke)</i> <i>(New Info)</i></p> | <p><i>Fault traced to the clearance hole for PS4 flag, which was found to be blocked by Mylar?</i> This Mylar is part of a section of 3 fingers above the Vertical Pass path. One of these fingers somehow become bent and was causing PS4 to be permanently operated. This most likely was caused by customer pulling a sheet of paper back down after a paper jam. <i>Please note, this was very difficult to observe.</i></p> |
| <p>13.1 PAPER JAM's as sheet is about to enter the Fuser assy. <i>(New Info)</i> <i>(Bob Hagget, B'stoke, Nov 93)</i></p> | <p>Toner had built up on a black plastic guide plate on fuser assy (page 8a-69, item 29) and was causing these paper jams. <i>Simply cleaning/chipping away this toner resolved this problem.</i></p> |
| <p>13.1 Paper Jams in DUPLEX Mode ONLY? <i>(Peter Salisbury - City Gate)</i> <i>(Oct 94)</i></p> | <p>Problem very intermittent, occurs every 15/250 pages. Paper under EP Drum & half way out of fuser into switchback. <i>The resolution was to replace the HVT3 Separation/Transfer HVPS.</i> Its a good idea to check the quality of paper being used.</p> |
| <p>13.1 Paper Jams as paper leaves Fuser & enters Switchback? <i>(Geoff Pearce - Leeds)</i> <i>(July - 94)</i></p> | <p>The Switchback was Disabled vis Stacker Control PCA DIP switches. No Paper Jams occurred directly up to Stacker. <i>Replacing Stacker Power Supply assy resolved this pbm.</i></p> |

Paper Path LED Identification

The paper path display below appears on the Operators Front Panel. Listed below this paper path diagram are the internal paper path sensors associated with the LED on the Operators Front Panel.

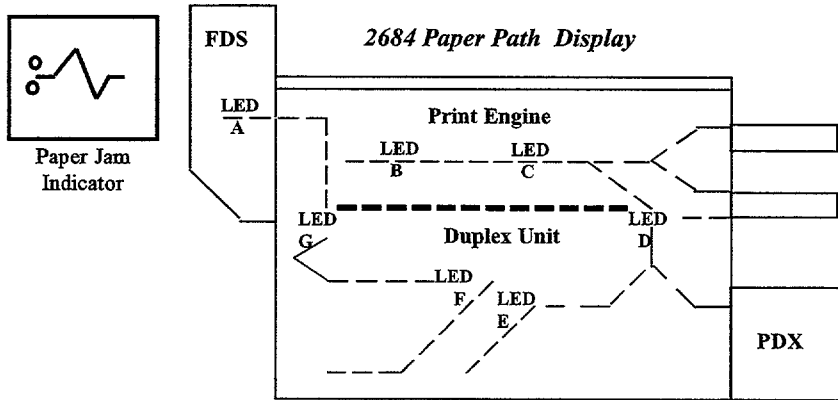

| Location | Sensor Number & Name |
|---|---|
| LED A---> Stacker (13.2 O/P Jam) | PS4 Main Tray Print Delivery Sensor PS5 Sub-Tray Print Delivery Sensor PS6 Switchback Feeder Paper Sensor 1 PS7 Switchback Feeder Paper Sensor 2 |
| LED B--->Print Engine (13.1 Paper Jam) | PS3 Fuser Delivery Sensor |
| LED C--->Print Engine (13.1 Paper Jam) | PS1 Separation Sensor |
| LED D--->Print Engine (13.1 Paper Jam) | PS4 Paper Inlet Sensor (PDX or Dup) |
| LED E--->Duplex (13.3 Duplex Jam) | PS3 Second Pass Pick-up Sensor |
| LED F--->Duplex (13.4 Clear Duplex Unit) | Q1 Holding Tray Sensor |
| LED G--->Stacker Duplex (13.3 Duplex Jam) | PS8 Duplex Unit Input Sensor PS1 Holding Tray Delivery Sensor |

PDX/Duplex Unit Troubleshooting Hints

If a Duplex Jam 13.3 occurs, the following procedure will help isolate that fault much easier than previous methods. **ENSURE the printer is NOT in CE MODE** as this may hide the cause of the problem. Also **listen for "Double Ping" 13.3 to 13.1**, by finishing at 13.1 this could misled CE into believing a Print Engine Jam had occurred.

Use the following method to determine if a paper jam has occurred in the duplex unit and if so, which part of the duplex did the jam occur?:

Setting switches 5 & 6 (SW1) on the PD/DU Controller PCA to the "ON" position enables LED's 1 to 4 (FIG 1) on the Display panel to display an ERROR CODE. This error gives the location of the paper jam in the duplex area.

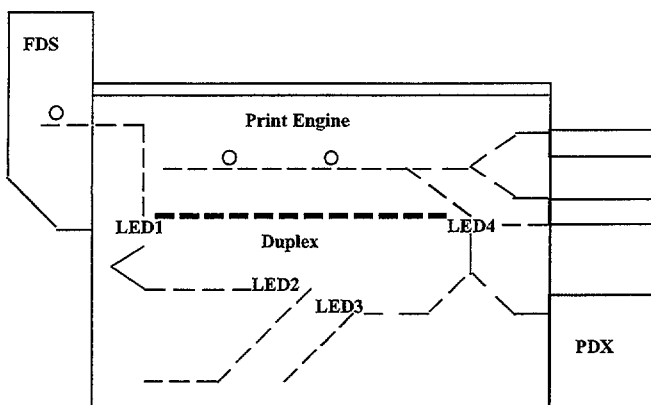

FIG 1 2684 Front Panel Display

There are two ways to use this troubleshooting aid:

Method 1

After Paper Jam has occurred, set switches 5 & 6 on the PU/DU Controller to the "ON" position. If jam was in the duplex area, an error code will be displayed using LED's 1 thru 4 (see above FIG1). The actual location can be verified using Table 1. *Two "Pings" occur, 13.3 then 13.1. When complete return switches 5 & 6 to "OFF".*

Method 2

Before Paper Jam occurs, set switches 5 & 6 "ON". LED's 1 thru 4 no longer function as a paper tracking device, they are enabled to an error reporting mode. Use Table 1 to identify the area of the paper jam. *(When complete set switches 5 & 6 to "OFF")*

Caution: Paper Jam is DISABLED (SW 5 "ON"), the duplex will attempt to MOVE paper. Damage may occur, due to the fact that paper jam is disabled. Also it is possible to get more than one error using using this method. **ALWAYS use the first error code reported.**

WARNING: NEVER LEAVE SWITCHES 5 & 6 ON DURING NORMAL CUSTOMER OPERATION!!!!(THIS ALSO APPLIES TO CE MODE)

Table 1 Jam Location Matrix

| Area | Jam Location | LED1 | LED2 | LED3 | LED4 |
|---------|--|------|------|------|------|
| (Fig 2) | No Jam Detected | 0 | 0 | 0 | 0 |
| A | Duplex Unit Inlet Jam | 1 | 0 | 0 | 0 |
| B | Holding Tray Delivery Jam: a) Delay in paper reaching the holding tray. | 0 | 1 | 0 | 0 |
| | b) Build-up of paper in the holding tray. | 1 | 1 | 0 | 0 |
| C | Holding Tray Jam | 0 | 0 | 1 | 0 |
| D | 2nd Pass Pick-up Jam | 1 | 0 | 1 | 0 |
| E | Vertical Pass Jam | 0 | 1 | 1 | 0 |
| F | Paper Inlet to the Print Engine Jam: a) Jam feeding paper from Duplex unit. | 1 | 1 | 1 | 0 |
| | b) Jam in feeding paper PDX unit. | 0 | 0 | 0 | 1 |

0 = LED "OFF" 1 = LED "ON"

To clear Error Code display, clear paper from the printer and open then close the front covers. This will reset the display.

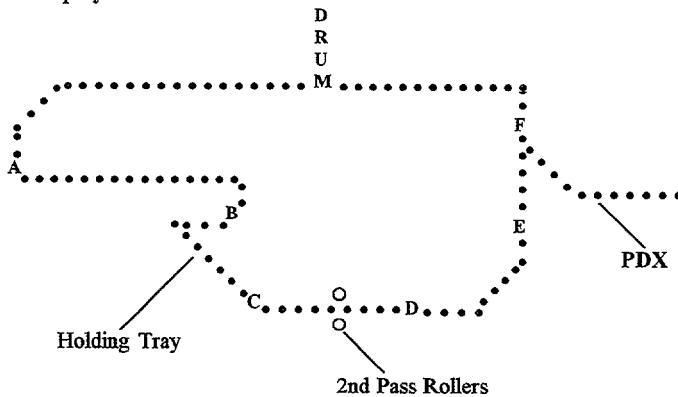

FIG2 Duplex Paper Path

The only limitation is the configuration of the printer's PD/DU Controller, PROM and CPU PCA.

The printer must have at a minimum:

PD/DU Controller RG1-0532-020CN (or > e.g. 070CN or 080CN)

PROM REV 6 (or > e.g. REV 7)

CPU PCA RG1-0403-020CN (or > e.g. 040CN or 070CN)

Note:
Since introduction of Rev 07 in just a few printers a problem has been noted as per page 7-29 (Entry " Paper Jam in Duplex and/or in Fuser Area"). In these cases use Rev 8.

2684 SCOPE ELIMINATION

Jim LaMontagne/NPR; Submitted by John Yelmgren/Midwest Region

The foldback mirror adjustment procedure currently requires a scope. This can be eliminated by using a 34301A RF Probe and a voltmeter. This new procedure is identical except that the RF Probe and voltmeter are used to find the maximum laser beam level instead of a scope.

The difference in the procedure is as follows :

- a). Attach the RF Probe to the D.C. voltmeter input. The meter that should be used is of the HP E237xA series. The meter should be set for measuring DC volts and auto-ranging.
- b). Attach the RF probe input to the beam detect test point on the DC Controller TP101) and the ground lead to TP102
- c). Adjust the foldback mirror for the peak DC voltage on the meter. See the chart below to correlate the probe readings to the peak to peak signal seen with a scope. These values can be used to ensure adequate laser beam levels and for troubleshooting.

| Scope peak to peak reading | RF Probe output DC Volts |
|--|--------------------------|
| no beam (noise level) to .2 volts PP | 0.0025 to .003 Volts |
| 0.4 volts PP | 0.017 Volts |
| 0.6 " | 0.067 " |
| 0.8 " | 0.153 " |
| 0.9 " | 0.220 " |
| 1.0 " | 0.260 " |
| 1.20 " | 0.350 " |
| 1.40 " | 0.461 " |
| 1.50 " | 0.512 " |
| 1.60 " | 0.600 " |
| 1.85 " | 0.764 " |

The 34301A RF probe should be in the kit with the normal 2684 tools; some of which also require the use of a voltmeter. This new procedure should save the CE's the time and effort required to take and setup a scope at the customer site.

Please contact me if there are any questions or problems in using the above information.

John Yelmgren
MSR CEC
891-0292

LJ2000 - How to Identify a Friction Drive or a Positive Drive Switchback

Friction Drive

1. Serial Number < 2913J02862.
2. Deflector Roller RF1-0328-040CN (Page 8b-22 item 64) has black tyres on its rollers.
3. Look at all rollers in switchback, you will observe that many are NOT directly driven gears. Instead, they friction driven from a directly driven roller.
4. As viewed from Front of Printer:

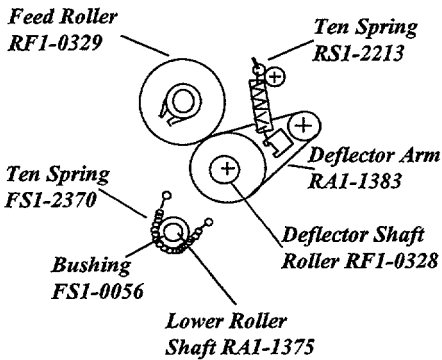

Positive Drive

1. Serial Number => 2913J02862.
2. Deflector roller RF1-2288-000CN has solid rollers, a white plastic material
3. You will note here that ALL rollers are driven and none rely on friction at all. (view end of switchback rollers from front) (of printer, with switchback covers off)
4. As viewed from Front of Printer:

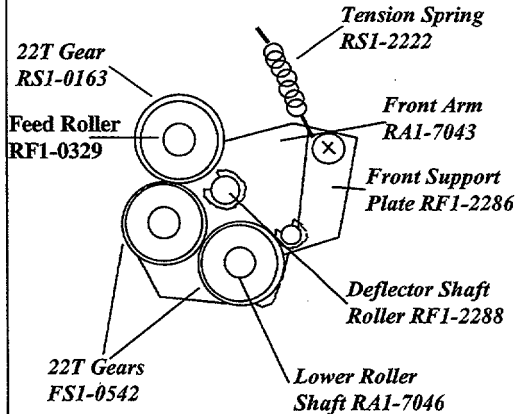

Note: The Deflector Shaft is easily identifiable by means of the 9 white Triangular Deflectors on its shaft, see Fig 8b-10 in Service Manual. Paper from the fuser first enters this area in the Switchback.

Main Parts Differences

Feed Roller RF1-0329-040CN
 Deflector Roller RF1-0328-040CN
 Lower Roller RA1-1375-000CN

Tension Spring FS1-2370-000CN (Black)
 Tension Spring RS1-2213-000CN (Long)
 Deflector Arm RA1-1383-000CN

Feed Roller RF1-0329-040CN
 Deflector Roller RF1-2288-000CN
 Lower Roller RA1-7046-000CN

Compress Spring RS1-2069-000CN (1)
 Fibre Washer RA1-7044-000CN (1)
 Fibre Washer RA1-1575-000CN (1)
 Rubber Washer RS1-6021-000CN (1)

Note (1): These items will be found on the end of the Lower Roller, see page 7-20 in this book for detail.

See Service Note 2684A-10 for Geater Detail

Running Standard Self-Test

Take printer OFF-LINE and press SELF-TEST key. The self-test page will then be printed.

Running CE Mode Paper Path Test

1. Power off printer.
2. Open access door on RH end of the Formatter and I/O area.
3. On Formatter PCA, set switch S12-2 to CLOSED (see page 6-25 in service manual)
4. Power ON the printer.
5. After warm-up take printer OFF-LINE.
6. Press MENU key until SELF TEST: STANDARD appears.
7. Press the UP arrow key, press SHIFT key to display "s" at right.
8. Press ENTER key to change the display to an asterisk (*).
9. Press MENU key to return to "00 PRINTER READY".
10. Press SELF-TEST key. 12 pages will printer (4 from each source, 6 duplex)

Note: DO NOT leave in CE MODE.

Running Factory RUN-IN Mode Paper Path Test

Adopt same process as above but this time set both S12-2 and S12-3 to CLOSED

This will print 180 page (60 from each I/P source) in a combination of Simplex, Duplex pages. Some pages will be emitted from the ERROR tray and the remainder from the O/P tray. This is quite a comprehensive test to use.

Note: DO NOT leave in CE MODE/RUN-IN MODE